



DHV CONSULTANTS &  
DELFT HYDRAULICS with  
HALCROW, TAHAL, CES,  
ORG & JPS

***VOLUME 4  
HYDROMETRY***

***DESIGN MANUAL***

## Table of Contents

<b>1</b>	<b>INTRODUCTION</b>	<b>1</b>
1.1	GENERAL	1
1.2	DEFINITION OF VARIABLES AND UNITS	2
<b>2</b>	<b>PHYSICS OF RIVER FLOW</b>	<b>5</b>
2.1	GENERAL	5
2.2	CLASSIFICATION OF FLOWS	5
2.3	VELOCITY PROFILES	8
2.4	HYDRAULIC RESISTANCE	10
2.5	UNSTEADY FLOW	14
2.6	BACKWATER CURVES	17
<b>3</b>	<b>HYDROMETRIC NETWORK DESIGN</b>	<b>21</b>
3.1	INTRODUCTION	21
3.2	NETWORK DESIGN CONSIDERATIONS	22
3.2.1	CLASSIFICATION	22
3.2.2	MINIMUM NETWORKS	22
3.2.3	NETWORKS FOR LARGE RIVER BASINS	23
3.2.4	NETWORKS FOR SMALL RIVER BASINS	23
3.2.5	NETWORKS FOR DELTAS AND COASTAL FLOODPLAINS	23
3.2.6	REPRESENTATIVE BASINS	24
3.2.7	SUSTAINABILITY	24
3.2.8	DUPLICATION AVOIDANCE	24
3.2.9	PERIODIC RE-EVALUATION	24
3.3	NETWORK DENSITY	24
3.3.1	WMO RECOMMENDATIONS	24
3.3.2	PRIORITISATION SYSTEM	25
3.3.3	STATISTICAL AND MATHEMATICAL OPTIMISATION	26
3.4	THE NETWORK DESIGN PROCESS	26
<b>4</b>	<b>SITE SELECTION OF WATER LEVEL AND STREAMFLOW STATIONS</b>	<b>28</b>
4.1	DEFINITION OF OBJECTIVES	28
4.2	DEFINITION OF CONTROLS	28
4.3	SITE SURVEYS	29
4.4	SELECTION OF WATER LEVEL GAUGING SITES	31
4.5	SELECTION OF STREAMFLOW MEASUREMENT SITE	31
<b>5</b>	<b>MEASURING FREQUENCY</b>	<b>34</b>
5.1	GENERAL	34
5.2	STAGE MEASUREMENT FREQUENCY	35
5.3	CURRENT METER MEASUREMENT FREQUENCY	36
<b>6</b>	<b>MEASURING TECHNIQUES</b>	<b>38</b>
6.1	STAGE MEASUREMENT	38
6.1.1	GENERAL	38
6.1.2	VERTICAL STAFF GAUGES	39
6.1.3	INCLINED STAFF OR RAMP GAUGES	42
6.1.4	CREST STAGE GAUGES	43
6.1.5	ELECTRIC TAPE GAUGES	44
6.1.6	FLOAT SYSTEM WITH AUTOGRAPHIC RECORDING	45
6.1.7	FLOAT SYSTEM WITH DIGITAL RECORDING	50
6.1.8	PRESSURE SENSORS (TRANSDUCERS)	52
6.1.9	DATA LOGGERS	59

6.1.10	SELECTION OF STAGE AND WATER LEVEL SENSORS AND RECORDING EQUIPMENT	63
6.2	INTRODUCTION TO VELOCITY AREA METHOD OF STREAMFLOW MEASUREMENT	64
6.2.1	BASIC PRINCIPLES	64
6.2.2	FACTORS AFFECTING VELOCITY DISTRIBUTION IN OPEN CHANNELS	66
6.2.3	DISTRIBUTION OF VELOCITY	69
6.3	FLOAT MEASUREMENT	70
6.3.1	BACKGROUND	70
6.3.2	TYPES OF FLOAT	71
6.3.3	FLOAT MEASUREMENT TECHNIQUE	72
6.3.4	DETERMINATION OF DISCHARGE FROM SURFACE FLOAT VELOCITY MEASUREMENTS	74
6.4	CURRENT METER STREAMFLOW MEASUREMENT	76
6.4.1	INTRODUCTION	76
6.4.2	ROTATING ELEMENT CURRENT METERS	76
6.4.3	TYPES OF CURRENT METER	78
6.4.4	METHODS OF SUSPENSION AND DEPLOYMENT OF CURRENT METERS	81
6.4.5	SPACING OF VERTICALS	86
6.4.6	MEASUREMENT OF WIDTH, HORIZONTAL DISTANCE OR POSITION IN THE HORIZONTAL	88
6.4.7	MEASUREMENT OF DEPTH	91
6.4.8	SKEW EFFECTS	97
6.4.9	METHODS OF ESTIMATING MEAN VELOCITY IN THE VERTICAL	98
6.4.10	LEGITIMATE SHORT CUTS	100
6.4.11	COMPUTATION OF DISCHARGE	100
6.4.12	ERROR ANALYSIS VELOCITY AREA METHOD	101
6.4.13	MINIMISING ERRORS IN CURRENT METER DISCHARGE MEASUREMENTS	106
6.4.14	ELECTROMAGNETIC CURRENT METER	106
6.5	ACOUSTIC DOPPLER CURRENT PROFILER (ADCP)	107
6.5.1	INTRODUCTION	107
6.5.2	BASIC PRINCIPLES OF DOPPLER VELOCITY METERS	108
6.5.3	ADCP FUNCTIONING AND COMPONENTS	110
6.5.4	PRACTICAL USE OF THE ADCP	113
6.5.5	COLLECTING DISCHARGE DATA WITH A SONTEK ADP	118
6.5.6	PROCESSING OF SONTEK ADP DATA	120
6.5.7	ADCP - GLOSSARY OF TERMS	123
6.6	SLOPE - AREA METHOD	125
6.6.1	INTRODUCTION	125
6.6.2	PRINCIPLES OF THE METHOD OF MEASUREMENT	125
6.6.3	ESTIMATION OF VELOCITY HEAD AND DISCHARGE	128
6.6.4	ESTIMATION OF MANNING'S COEFFICIENT	128
6.6.5	COMPOSITE SECTIONS	129
6.6.6	STATE OF FLOW	130
6.7	COMPARISON AND APPLICATION OF DIFFERENT FLOW MEASUREMENT TECHNIQUES	130
<b>7</b>	<b>EQUIPMENT SPECIFICATIONS</b>	<b>134</b>
7.1	INTRODUCTION	134
7.2	PREPARATION OF STAGE AND STREAM FLOW MEASUREMENT INSTRUMENTATION AND EQUIPMENT TENDER SPECIFICATIONS	135
7.2.1	INTRODUCTION	135
7.2.2	SITE SURVEYS AND INSTALLATION PLANNING	135
7.2.3	TENDER PACKAGES	136

---

7.2.4	RESOLUTION AND ACCURACY	137
7.2.5	HYDROMETRIC SENSOR AND EQUIPMENT SELECTION CRITERIA	137
7.2.6	INSTRUMENT AND EQUIPMENT SPECIFICATIONS	138
7.2.7	OTHER ITEMS TO BE INCLUDED IN THE SPECIFICATIONS	141
7.3	INTERPRETATION OF EQUIPMENT SPECIFICATION AND ASSESSMENT OF PRODUCTS AND SUPPLIERS	143
7.3.1	INTERPRETING EQUIPMENT SPECIFICATIONS	143
7.3.2	EVALUATION OF SPECIFICATIONS	143
7.4	EQUIPMENT SPECIFICATIONS	145
<b>8</b>	<b>STATION DESIGN, CONSTRUCTION AND INSTALLATION</b>	<b>147</b>
8.1	DESIGN AND INSTALLATION CRITERIA - WATER LEVEL MONITORING	147
8.1.1	STAFF GAUGES	147
8.1.2	BENCH MARKS	149
8.1.3	STILLING WELLS	149
8.1.4	DWLR - PRESSURE SENSOR TYPE	154
8.1.5	INSTRUMENT PROTECTION AND HOUSINGS	157
8.2	DESIGN AND INSTALLATION CRITERIA - CURRENT METER GAUGING INSTALLATIONS	158
8.2.1	GENERAL	158
8.2.2	WADING GAUGING SITES	159
8.2.3	BRIDGE GAUGING	159
8.2.4	CABLEWAY GAUGING	160
8.2.5	BOAT GAUGING	165
8.3	SITE OFFICES AND STORES	166
8.3.1	SITE TYPES	166
8.3.2	ASSUMPTIONS	167
8.3.3	GUIDELINES	167
8.3.4	POSSIBLE BUILDING REQUIREMENTS	168
<b>9</b>	<b>REFERENCES</b>	<b>169</b>

# 1 INTRODUCTION

## 1.1 GENERAL

The branch of Geophysics, which deals with the occurrence and movement of water in terms of quantities and quality on and below the surface of the earth except the oceans, in vapour, liquid or solid state, is termed Hydrology. For hydrological design and water resources assessment purposes proper estimates of river flow and river stages are required. Their measurement is the domain of hydrometry.



*Figure 1.1:  
Hydrometric station*

The measurement of river stages and discharges at the observation stations is dealt with in this Volume 4 “Hydrometry” of the “Manual on Hydrological Field Measurements and Data Processing”. This volume on hydrometry includes **how** measurements are made, **with what** equipment, **where** and **when**. Volume 4 consists of three parts:

1. Design Manual, in which the basic principles and procedures are put in context
2. Reference Manual, for details on specific topics, and
3. Field Manual, dealing with operational procedures at the observation station.

This part of Volume 4 covers the Design Manual: ‘Hydrometry’. It is set up as follows:

- Chapter 1 deals with definition of quantities and units and unit conversions.
- Some basic hydraulic principles as far as relevant for hydrometry are dealt with in Chapter 2.
- In Chapter 3 the design and optimisation of hydrometric networks are discussed. Network densities are related to measurement objectives, spatial variation of the phenomena and cost of installation and operation.

- Once the network density has been specified the sites for the water levels and discharges have to be selected. Criteria for site selection are discussed in Chapter 4.
- Next, in Chapter 5 the observation frequency to be applied for the various hydrological quantities in view of the measurement objectives and temporal variation of the observed processes are treated.
- The measurement techniques for observation of hydrometric variables and related equipment are dealt with in Chapter 6.
- Since the buyers of the hydrometric equipment are often neither sufficiently familiar with the exact functioning of (parts of) the equipment nor with the background of the specifications, remarks on the equipment specifications have been added in Chapter 7. The equipment specifications proper are covered in a separate and regularly updated volume: "Equipment Specification Surface Water".
- Guidelines on station design and equipment installation are dealt with in Chapter 8.

In the Field Manual operational practices in running the network stations are given. It also includes field inspections, audits and last but not least, the topic of equipment maintenance and calibration.

### Notes

- The content of this part of the manual deals only with hydrometric measurements in the States of Peninsular India. The equipment discussed is used or appropriate for use in the Hydrological Information System. Hence, the manual does not provide a complete review of all techniques and equipment applied elsewhere.
- The procedures dealt with in this manual are conformably to BIS and ISO standards. It is essential that the procedures described in this manual are closely followed to guarantee a standardised approach in the entire operation of the Hydrological Information System.

## 1.2 DEFINITION OF VARIABLES AND UNITS

In this section definitions, symbols and units of relevant quantities and parameters when dealing with hydrometry are given. The use of standard methods is an important objective in the operation of the Hydrological Information System (HIS). Standard methods require the use of a coherent system of units with which variables and parameters are quantified. This section deals with the system of units used for the measurement of hydrological quantities.

Quantity	Symbol	Unit	Quantity	Symbol	Unit
<b>Density</b>			<b>Head</b>		
Density of water	$\rho$	kg.m <sup>-3</sup>	Velocity head	$h_v$	m
Density of sediment,	$\rho_s$	kg.m <sup>-3</sup>	Pressure head	$h_p$	m
Relative density under water	$\Delta=(\rho_s-\rho)/\rho$	[-]	Energy head	$H_e$	m
<b>Pressure</b>			<b>Slope</b>		
Air pressure	$p_a$	kPa	Slope/gradient (general)	S	[-]
Water pressure	$p$	kPa	Bottom/bed slope/gradient	$S_0$	[-]
<b>Temperature</b>			Water surface slope/gradient	$S_w$	[-]
Water temperature	$T_w, t_w$	°C or K	Energy slope/gradient	$S_e$	[-]
Air temperature	$T_a, t_a$	°C or K	<b>Discharge</b>		
<b>Level, depth, area</b>			Flow velocity	$u, v, w$	m.s <sup>-1</sup>
Water depth	$y, h$	m	Discharge	Q	m <sup>3</sup> .s <sup>-1</sup>
Wetted perimeter	P	m	Discharge per unit width	q	m <sup>2</sup> .s <sup>-1</sup>
Wetted area	A	m <sup>2</sup>	<b>Characteristic numbers</b>		
Hydraulic radius	R	m	Reynolds number	Re	[-]
Equilibrium or normal depth	$y_n, h_n$	m	Froude number	Fr	[-]
Critical depth	$y_c, h_c$	m			

Table 1.1: Overview of relevant quantities, symbols and units used in hydrometry

---

### **General terms**

**Control:** The physical properties of a channel, natural or artificial, which determine the relationship between stage and discharge at a location in the channel.

**Stable channel:** Channel in which the bed and the sides remain sensibly stable over a substantial period of time in the control reach and in which scour and deposition during the rising and falling floods is inappreciable.

**Unstable channel:** Channel in which there is frequently and significantly changing control.

**Reach:** A length of open channel between two defined cross-sections

**Invert:** The lowest part of the cross-section of a natural or artificial channel.

**Wetted perimeter, P [m]:** The wetted boundary of an open channel at a specified section.

**Cross-section of stream, A [m<sup>2</sup>]:** A specified section of the stream normal to the direction of flow bounded by the wetted perimeter and the free water surface.

**Hydraulic radius, R [m]:** The quotient of the wetted cross-sectional area and the wetted perimeter.

### **Level, depth and gradient**

**Stage, y, h [m]:** Height of water surface of a stream, river, lake or reservoir at the measuring point above an established datum plane.

**Gauge height, h [m]:** Water surface elevation relative to the gauge datum.

**Water depth D, h [m]:** Vertical distance between water surface and river bottom.

**Normal/equilibrium depth, [m]:** Flow depth under steady, uniform flow conditions.

**Critical depth, [m]:** The depth of flow when the flow is critical ( $Fr = 1$ ), see Chapter 2.

**Gauge:** The device installed at the gauging station for measuring the level of the water surface relative to datum. If the gauge is linked to a standard system of levels then the gauge is a reference gauge.

**Water level recorder:** A device which records automatically, either continuously or at frequent time intervals, the water level as sensed by a float, a pressure transducer, a gas bubbler, acoustic device, etc.

**Stilling well:** A well connected to the main stream in such a way as to permit the measurement of the stage in relatively still water.

**Surface slope:** The difference in elevation of the surface of the stream per unit horizontal distance measured in the direction of flow.

**Bed/bottom slope:** The difference in elevation of the bed per unit horizontal distance measured in the direction of flow.

**Backwater curve:** The profile of the water surface upstream when its surface slope is generally less than the bed slope. The backwater curve occurs upstream of an obstruction or confluence.

**Draw-down curve:** The profile of the water surface when its surface slope exceeds the bed slope.

**Afflux:** The rise in water level immediately upstream of, and due to, an obstruction.

**Elevation/potential head, [m]:** The height of any particle of water above a specified datum (potential energy per unit of weight relative to a horizontal datum).

---

**Pressure head, [m]:** Height of liquid in a column corresponding to the weight of the liquid per unit area.

**Piezometric head, [m]:** Sum of elevation head and pressure head, or above a datum, the total head at any cross-section minus the velocity head at that cross-section.

**Velocity head, [m]:** The head obtained by dividing the square of the velocity by twice the acceleration due to gravity. In applying the mean velocity in the cross-section, a correction factor is to be applied for non-uniformity of the velocity profile in the cross-section.

**Total energy head, [m]:** The sum of the elevation of the free water surface above a horizontal datum of a section, and the velocity head.

**Specific energy, [m]:** The sum of the elevation of the free water surface above the bed, and the velocity head.

**Energy gradient, [-]:** The difference in total energy head per unit horizontal distance in the direction of flow.

**Stage-discharge relation:** A curve, table or function, which expresses the relation between the stage and the discharge in an open channel at a given cross-section for a given condition of flow (rising, steady or falling)

### ***Flow and flow types***

**Discharge, [m<sup>3</sup>/s]:** Volume of liquid/water flowing through a cross-section per unit of time.

**Velocity, [m/s]:** Rate of movement past a point in a specified direction.

**Laminar flow:** Type of flow mainly determined by viscosity  $Re < 500$ , see Chapter 2

**Turbulent flow:** Type of flow which is hardly determined by viscosity:  $Re > 2000$ , see Chapter 2.

**Sub-critical flow:** The flow in which the Froude number is less than unity and surface disturbances can travel upstream, see Chapter 2.

**Super-critical flow:** The flow in which the Froude number is greater than unity and surface disturbances will not travel in upstream direction, see Chapter 2.

**Critical flow:** The flow at which the total energy head is at minimum for a given discharge; under this condition the Froude number will be equal to unity and surface disturbances will not travel in upstream direction, see Chapter 2.

**Steady flow:** Flow in which the depth and velocity remain constant with respect to time, see Chapter 2.

**Uniform flow:** Flow in which the depth and velocity remain constant with respect to distance, see Chapter 2.

**Friction, drag:** Boundary shear resistance, which opposes the flow of water.

**Friction coefficient:** A coefficient used to calculate the energy gradient caused by friction.

**Rugosity coefficient:** A coefficient linked with the boundary roughness and the geometric characteristics of the channel used in the open channel flow formulae, like Chezy coefficient, Manning's coefficient, etc.

**Hydraulic jump:** Sudden change of flow from super-critical flow to sub-critical flow.



## 2 PHYSICS OF RIVER FLOW

### 2.1 GENERAL

In this chapter an overview is given of some relevant subjects of hydraulics, including:

- classification of flows: laminar versus turbulent flow, sub-critical, critical and supercritical flow and steady and unsteady flow, varying gradually or rapidly,
- flow velocity profiles for laminar and turbulent flow conditions,
- hydraulic roughness,
- unsteady flow features, and
- backwater computations.

Detailed derivations of the flow equations are provided in Volume 4, Reference Manual, Hydrometry.

### 2.2 CLASSIFICATION OF FLOWS

Flows in rivers are classified according to the forces acting on a mass of fluid. These are:

gravity  $F_g = M.g = \rho L^3 g$  (M = mass; g = gravitational acceleration;  $\rho$  = density; L = length)

pressure  $F_p = p.A = \rho L^2$  ( $\rho$  = pressure; A = area)

viscosity  $F_v = \tau.A = \rho \nu v L$  ( $\tau$  = shear stress;  $\nu$  = kinematic viscosity; v = velocity)

surface tension  $F_\sigma = \sigma.L = \sigma L$  ( $\sigma$  = surface tension)

elasticity  $F_e = K.A = KL^2$  (K = bulk modulus of elasticity)

inertia  $F_i = M.a = \rho v^2 L^2$  (a = acceleration)

Generally, one of these forces predominates. The inertial force is always present. To characterise the physical phenomena, the forces are compared with the inertial force leading to characteristic numbers. For river flow or open channel flow the Reynold(s) number and Froude number are of importance.

#### ***Reynolds number***

The Reynolds number Re compares the viscous force with the inertial force:

$$Re \equiv \frac{F_i}{F_v} = \frac{\rho v^2 L^2}{\rho \nu v L} = \frac{vL}{\nu} \quad (2.1)$$

For river flow the flow depth h is taken as the characteristic length L: so  $L \rightarrow h$ . Hence, it follows from (2.1):

$$Re \equiv \frac{vh}{\nu} \quad (2.2)$$

The Reynolds number distinguishes between laminar and turbulent flow:

- laminar flow:  $Re < 600$
- transitional flow:  $600 \leq Re < 2000$
- turbulent flow:  $Re > 2000$

Laminar flow is best described as thin sheets of water (laminae) moving in straight lines parallel to each other, although the velocities of one sheet may not be the same as the one beside it. In this situation the viscosity is very strong relative to the inertia forces. Viscosity is the resistance of movement of one layer of fluid to another. Very simply it is a measure of a liquid's "stickiness". In a turbulent flow situation, the path of the fluid particles is no longer straight as the viscous forces are weak relative to the inertial forces. Therefore flows are sinuous and intertwining with each other so that thorough mixing takes place. In turbulent flow there are continuous variations in velocity (and pressure) at every point, so only laminar flow can be considered steady. Turbulent flow is only steady if the average velocity and pressure remain constant over a reasonable time period.

Since the viscosity of water is about  $10^{-6} \text{ m}^2/\text{s}$  at a temperature of  $20 \text{ }^\circ\text{C}$  it is observed from the Reynolds number that in nearly all cases river flow is turbulent; only sheet flow with very low velocities will behave as laminar flow. The fact that river flow is turbulent has consequences for measurement of stage and of flow velocities. A real instantaneous value will give insufficient information about the state of flow; time averaged values over periods of 0.5 to several minutes have to be considered instead.

### ***Froude number***

The Froude number  $Fr$ , which compares the gravity force with the inertial force:

$$Fr^2 = \frac{F_i}{F_g} = \frac{\rho v^2 L^2}{\rho L^3 g} = \frac{v^2}{gL} \quad (2.3)$$

The Froude number reads with  $L$  replaced by the flow depth  $h$  (or for a channel with non-uniform cross-section: cross-sectional area/stream width at the surface):

$$Fr \equiv \frac{v}{\sqrt{gh}} \quad (2.4)$$

The Froude number compares the celerity of dynamic waves  $\sqrt{gh}$  with the flow velocity  $v$ :

- sub-critical flow:  $Fr < 1$                       flow is slow
- critical flow:  $Fr = 1$                         flow has unique depth  $h_c =$  critical flow depth
- supercritical flow:  $Fr > 1$                     flow is fast

The specific energy of the flow in a particular cross-section ( $h + v^2/2g$ ) is at a minimum for one particular depth, called the critical depth  $h_c$ . For a particular discharge there can only one depth be critical. Hence, when the flow is critical, there is a unique relation between stage at discharge. Of this feature use is made of in flow measuring structures. Critical flow is obtained in the transition from a mildly sloped channel where the flow is sub-critical to a steep channel with very high flow velocities, where the flow is super-critical. As is observed from the definition of the Froude number in natural rivers where gauging takes place often the condition  $Fr \ll 1$  applies, so one is generally dealing with sub-critical flow.

### **Flow classification on temporal and spatial variation of flow velocity and depth.**

Classification of open channel flow can also be based on the temporal and spatial variation of the mean flow velocity  $v$  and mean flow depth  $h$ :  $v = v(x,t)$  and  $h = h(x,t)$  as shown in Table 2.1 (see also Figure 2.1):

**Steady Flow:** Depth of flow does not change with respect to the time period under consideration.

**Unsteady Flow:** Depth of flow is constantly changing within the time period.

**Uniform Flow:** Depth of flow does not change with distance under consideration along the channel.

**Non-Uniform Flow:** Depth varies with distance.

**Gradually Varied Flow:** Depth of flow varies very little over a large distance of channel.

**Rapidly Varied Flow:** Depth of flow changes rapidly over a comparatively short distance, e.g. in a hydraulic jump

Gradually varied flow occurs in most gradually sloping river systems in India. Rapidly varied flow occurs at such features as weirs and waterfalls.

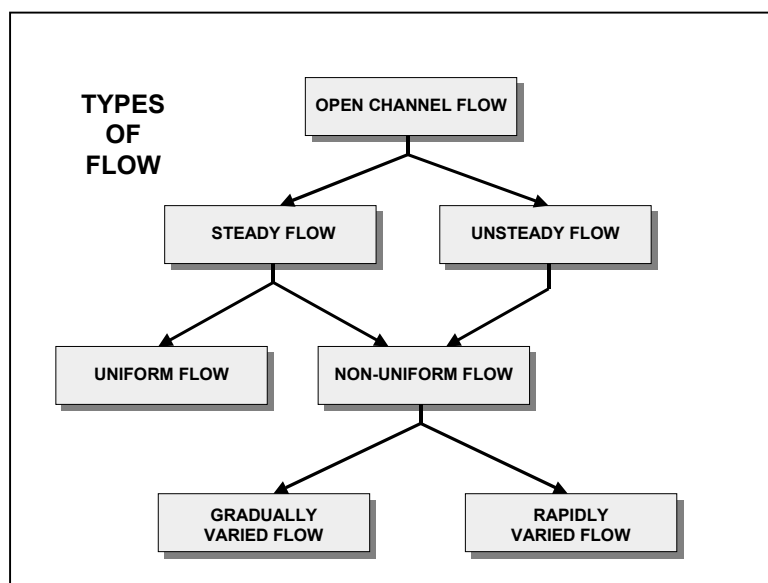

Figure 2.1:  
Flow classification based on temporal and spatial variation of flow velocity and flow depth

Flow condition		$ \partial v/\partial x $	$ \partial v/\partial t $	$ \partial h/\partial x $	$ \partial h/\partial t $	
Steady flow			0		0	
	Uniform flow	0	0	0	0	
	Non-uniform or varied flow	> 0	0	> 0	0	
				Gradually varied flow	small	0
				Rapidly varied flow	large	0
Unsteady flow			> 0		> 0	

Table 2.1: Classification of flows based on temporal and spatial variation of flow depth

## 2.3 VELOCITY PROFILES

Consider steady uniform flow. Then, the streamlines are parallel to the riverbed, so bed slope  $S_0 =$  water surface slope  $S_w =$  energy slope  $S_e$ , pressure distribution is hydrostatic and accelerations are zero. The velocity profile is then obtained from a balance of forces in flow direction and a relation between shear stress and velocity (see Volume 4, Reference Manual).

### **Laminar flow**

In case of laminar flow the velocity profile is parabolic and reads:

$$v(y) = \frac{gS_0}{\nu} \left( hy - \frac{1}{2} y^2 \right) \quad (2.5)$$

where:  $v(y)$  = flow velocity at distance  $y$  from river bed  
 $h$  = flow depth  
 $S_0$  = river bed slope  
 $\nu$  = kinematic viscosity  
 $g$  = gravitational acceleration

By integration over the depth of flow for the average flow velocity  $\bar{v}$  it follows:

$$\bar{v} = \frac{gS_0}{3\nu} h^2 \quad (2.6)$$

Note that  $\bar{v} \propto S_0$ , which is characteristic for laminar flow. By comparison of (2.5) with (2.6) it is observed that the average flow velocity is equal to the velocity at a depth  $y = (1-1/3\sqrt{3})h \approx 0.42h$ .

### **Turbulent flow**

In case of turbulent flow close to the bottom a very thin laminar sub-layer of depth ' $\delta$ ' exists where the velocity profile varies linearly with depth. Above the sub-layer the velocity profile is logarithmic, which is characteristic for fully developed turbulent flow (see Figure 2.2). It is customary to use the shear velocity  $u_*$  in the expressions for the velocity profiles, which is defined by:

$$u_* = \frac{\sqrt{\tau_0}}{\rho} = \sqrt{ghS_0} \quad (2.7)$$

where  $\tau_0$  = bottom shear stress;  $\tau_0 = \rho ghS_0$

The velocity profiles read:

- In the laminar sub-layer:  $0 \leq y \leq \delta$ :

$$v(y) = \frac{u_*^2}{\nu} y$$

- Above the laminar sub-layer:  $y > \delta$ :

$$v(y) = \frac{u_*}{\kappa} \ln \left( \frac{y}{y_0} \right) \quad (2.8)$$

In equation (2.8)  $\kappa$  = the Von Karman constant, with  $\kappa \approx 0.4$ , and  $y_0$  is the value of  $y$  for which the velocity becomes zero according to the logarithmic profile:  $v(y_0) = 0$ . The linear and the logarithmic profile intersect at  $y = \delta$ . The thickness of the laminar sub-layer is given by:

$$\delta = 11.6 \frac{v}{u_*} \tag{2.9}$$

In stead of the abrupt change from a linear to a logarithmic velocity profile there is a transition zone extending from  $0.5\delta < y < 3\delta$  (i.e.  $5v/u_* < y < 30v/u_*$ ).

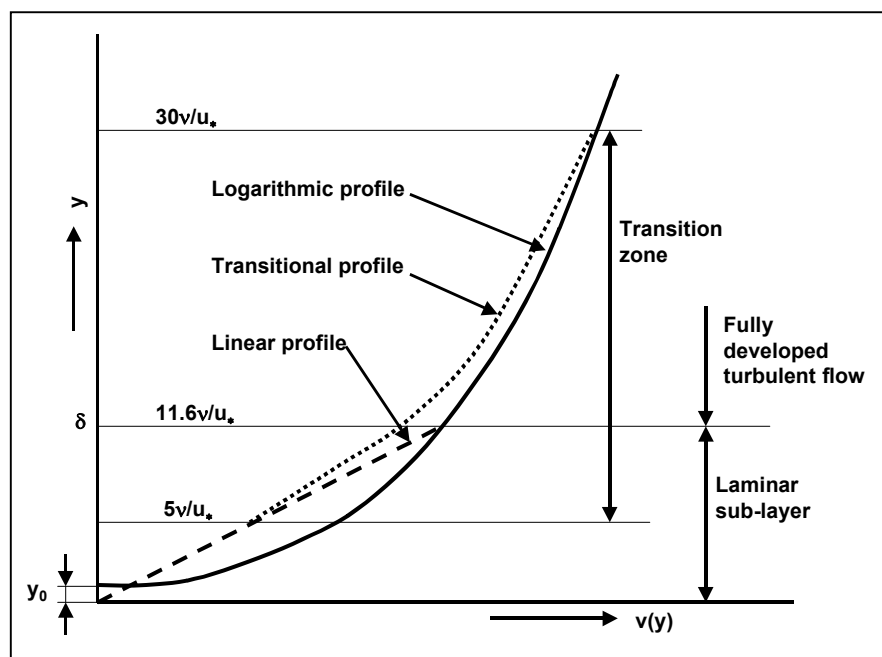

Figure 2.2:  
Velocity profile near bottom

For common values of  $h$  and  $S_0$  the thickness of the laminar sub-layer  $\delta \ll 1$  mm. Hence, the average velocity can safely be derived from equation (2.8) and reads:

$$\bar{v} = \frac{u_*}{\kappa} \left\{ \ln \left( \frac{h}{y_0} \right) - 1 + \frac{y_0}{h} \right\} \approx \frac{u_*}{\kappa} \ln \left( \frac{h}{e \cdot y_0} \right) \text{ because } y_0 \ll h \tag{2.10}$$

Following observations can be made:

- $\bar{v} \propto u_*$ , so  $\bar{v} \propto (S_0)^{1/2}$  and not proportional with  $S_0$  like for laminar flow
- $v(y) = \bar{v}$  for  $y = h/e = 0.368 h$

In equation (2.10) still  $y_0$  has to be determined. Its value depends on the roughness of the bottom, which is characterised by the **equivalent sand roughness**  $k_s$ . According to Nikuradse, a bed with roughness  $k_s$  produces the same resistance as a flat bed covered with fixed, uniform, closely packed sand grains with diameter  $k_s$ . Now the following bed/wall conditions apply:

if  $k_s < 0.3\delta$ , then the bed is **hydraulically smooth**, and:  $y_0 \approx \delta/117$  (2.11)

if  $k_s > 6\delta$ , then the bed is **hydraulically rough**, and:  $y_0 \approx k_s/32$  (2.12)

Combining (2.11) and (2.12) with (2.10) the velocity profiles and average velocities become:

- for a smooth **boundary** ( $k_s < 0.3\delta$ ):

$$v(y) = \frac{u_*}{\kappa} \ln\left(\frac{117y}{\delta}\right) \quad (2.13)$$

$$\bar{v} = \frac{u_*}{\kappa} \ln\left(\frac{12h}{\delta/3.5}\right) \quad (2.14)$$

- for a rough **boundary** ( $k_s > 6\delta$ ):

$$v(y) = \frac{u_*}{\kappa} \ln\left(\frac{32y}{k_s}\right) \quad (2.15)$$

$$\bar{v} = \frac{u_*}{\kappa} \ln\left(\frac{12h}{k_s}\right) \quad (2.16)$$

- for the **transition** between smooth and rough  $0.3\delta < k_s < 6\delta$  the average velocity follows from:

$$\bar{v} = \frac{u_*}{\kappa} \ln\left(\frac{12h}{k_s + \delta/3.5}\right) = \frac{\sqrt{g}}{\kappa} \ln\left(\frac{12h}{k_s + \delta/3.5}\right) \sqrt{hS_0} \quad \text{or :}$$

$$\bar{v} = 18 \log\left(\frac{12h}{k_s + \delta/3.5}\right) \sqrt{hS_0} \quad (2.17)$$

**Note:**

- The above formulae are valid for wide channels. For other cross-sections h has to be replaced by the hydraulic radius R.
- In view of the small value of  $\delta$  in fairly all natural conditions the bed can be considered as hydraulically rough. Hence, the equations (2.15) and (2.16) generally apply in practice.

## 2.4 HYDRAULIC RESISTANCE

Generally two flow equations are in use:

Chezy:  $\bar{v} = C(RS)^{1/2}$  (2.18)

Manning:  $\bar{v} = 1/n R^{2/3} S^{1/2}$  (2.19)

where: C = Chezy coefficient [ $m^{1/2}.s^{-1}$ ]

n = Manning's n-value for hydraulic roughness [ $m^{-1/3}.s$ ]

Using equation (2.17) and replacing flow depth h by the hydraulic radius R and combining the expression with (2.18) **White-Colebrook's formula** for hydraulic resistance is obtained:

$$C = 18 \log\left(\frac{12R}{k_s + \delta/3.5}\right) \quad (2.20)$$

where the denominator in (2.20) takes on the following values:

- For hydraulically **smooth** bed  $k_s \ll \delta$ , hence  $k_s + \delta/3.5 \approx \delta/3.5$
- For hydraulically **rough** bed  $k_s \gg \delta$ , hence  $k_s + \delta/3.5 \approx k_s$ .

**Strickler** proposed the following expression for C:

$$C = 25 \left( \frac{R}{k_s} \right)^{1/6} \quad (2.21)$$

Equations (2.20) and (2.21) are almost identical in the range  $40 < C < 70$ . Williamson (1951) found for concrete tubes the coefficient to be 26.4 instead of 25 for  $7.5 < R/k_s < 1500$ .

Combining (2.21) with (2.18) and comparing the result with (2.19) one obtains:

$$C = \frac{R^{1/6}}{n} = 25 \left( \frac{R}{k_s} \right)^{1/6}$$

Hence the following approximate relation between Manning's n and Nikuradse's  $k_s$ -value exists:

$$n = \frac{k_s^{1/6}}{25} = 0.04 k_s^{1/6} \quad (2.22)$$

The advantage of the use of  $k_s$  over n is its dimension [m]. The size of bed unevenness can be translated into a value for  $k_s$  (see below). This is at least true for the riverbed. For floodplain roughness with bushes etc. the relation between unevenness and  $k_s$  is less apparent.

### ***Some practical relations for $k_s$***

According to van Rijn (1984) for an alluvial bed the following values apply for the equivalent sand roughness  $k_s$ :

- For a **flat sandbed and gravelbed** it follows respectively:

$$k_s \approx 3D_{90} \quad (\text{sandbed}) \quad k_s \approx D_{90} \quad (\text{gravelbed}) \quad (2.23)$$

- For a **dune/ripple covered bed** (see Figure 2.3)

$$k_s \approx 1.1H \left( 1 - \exp\left(-25 \frac{H}{L}\right) \right) \quad (2.24)$$

where:  $D_{90}$  = characteristic grain size diameter (90% is finer)  
 H = dune/ripple height  
 L = dune/ripple length  
 H/L = dune/ripple steepness

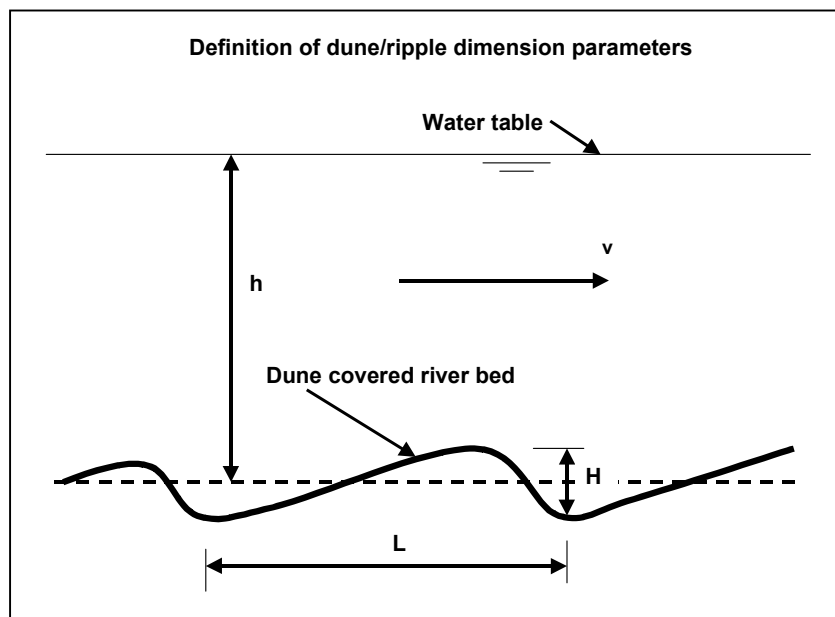

Figure 2.3:  
Dune/ripple dimension parameters

**Note:**

- For a flat sandbed values for  $k_s$  in the range of 1 to 10  $D_{90}$  were found with a median value  $3D_{90}$
- For steep dunes/ripples  $H/L$  is typically 0.1, then  $k_s = H$ , i.e. sand roughness about equal to the dune height (see Figure 2.4). If  $H/L \ll 0.1$  then  $k_s \ll H$ .
- Combining (2.22) with (2.23) one finds for a flat bed with  $D_{90} = 10$  mm an n-value of 0.022. A complete list of n-values for different bed conditions is given in Chapter 6.

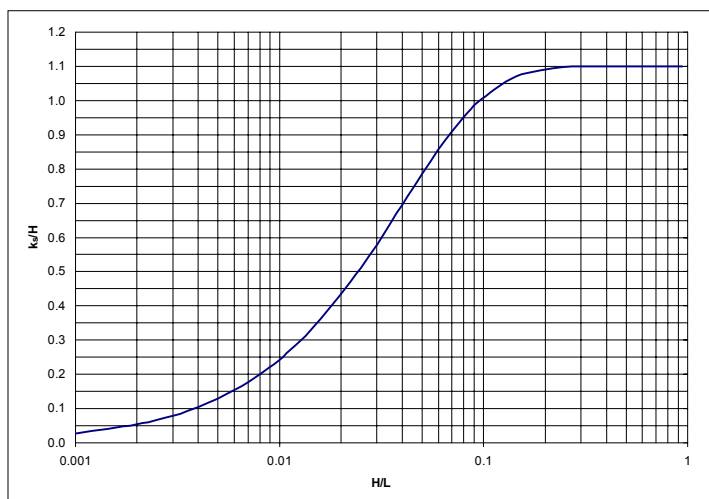

Figure 2.4:  
Hydraulic roughness as function of dune/ripple dimensions

**Dune/ripple dimensions**

For a dune/ripple covered bed the equivalent sand roughness  $k_s$  and hence also Manning’s n-value are not constant but will vary with flow depth and excess shear stress. Van Rijn (1984) developed the following relations between dune/ripple dimensions, grain size and the transport stage parameter  $T$ , defined below. The relations are valid for  $0 < T < 5$ :



$$\frac{H}{h} = c_{H,1} \left( \frac{D_{50}}{h} \right)^{0.3} (1 - e^{-0.5T})(25 - T) \quad \text{with : } c_{H,1} \approx 0.11 \quad (2.25)$$

$$\frac{H}{L} = c_{H/L,1} \left( \frac{D_{50}}{h} \right)^{0.3} (1 - e^{-0.5T})(25 - T) \quad \text{with : } c_{H/L,1} \approx 0.015 \quad (2.26)$$

where:  $D_{50}$  = median grain diameter  
 $c_{H,1}$  = coefficient in dune/ripple height relation  
 $c_{H/L,1}$  = coefficient in dune/ripple steepness relation  
 $T$  = van Rijn's transport stage parameter.

Based on a large number of field data Julien and Klaassen (1995) found that for  $T > 5$  relative dune height and dune steepness are no longer a function of  $T$ . The following relations apply for  $T > 5$ :

$$\frac{H}{h} = c_{H,2} \left( \frac{D_{50}}{h} \right)^{0.3} \quad \text{with: } 0.8 < c_{H,2} < 8 \quad \text{and: } \overline{c_{H,2}} = 2.5 \quad (2.27)$$

$$\frac{H}{L} = c_{H/L,2} \left( \frac{D_{50}}{h} \right)^{0.3} \quad \text{with: } 0.12 < c_{H/L,2} < 2 \quad \text{and: } \overline{c_{H/L,2}} = 0.4 \quad (2.28)$$

Substitution of (2.27) and (2.28) in (2.24) leads to:

$$k_s = \alpha h^{0.7} \{1 - \exp(-\beta h^{-0.3})\} \quad (2.29)$$

For  $T > 5$  the coefficients become:  $\overline{\alpha} = 3 D_{50}^{0.3}$  and  $\overline{\beta} = 10 D_{50}^{0.3}$ . Since  $D_{50}$  reduces in downstream direction, this would mean that the equivalent sand roughness also decreases towards the river mouth. Experience shows that this is not always the case.

The above equations provide a procedure to estimate the value of the hydraulic roughness based on measurable and predictable quantities: bed-material size and dune/ripple dimensions. It can also be used for design conditions, since it allows for extrapolation. In such cases it is necessary to calibrate the dune-dimension relationship and roughness on local data in view of the large variation in the coefficients  $c_H$  and  $c_{H/L}$ . To be able to carry out the computations the  $T$ -parameter has to be determined.

### **Transport stage parameter $T$**

The transport stage parameter  $T$  is a measure for the excess shear on the grains (shear stress above the critical shear stress, where the latter indicates the initiation of motion) and is defined by:

$$T = \frac{\theta' - \theta_{cr}}{\theta_{cr}} \quad (2.30)$$

where:

$$\theta' = \frac{\overline{v}^2}{C_g^2 \Delta D_{50}} \quad \text{with: } C_g = 18 \log \left( \frac{12R}{3D_{90}} \right) \quad (2.31)$$

$\theta_{cr}$  = dimensionless critical shear stress according to Shields; the latter is a function of  $D_*$ , defined by:

$$D_* = \left( \frac{\Delta g}{v^2} \right)^{1/3} D_{50} \quad \text{with: } v = \frac{4 \times 10^{-5}}{20 + t_c} \quad (2.32)$$

where:  $t_c$  = temperature in °C. The relation between  $D_*$  and  $\theta_{cr}$  is presented in Table 2.2. Note that the Shields curve refers to the situation that a large number of particles are put in motion.

$D_*$ -range	$\theta_{cr}$
$D_* \leq 4$	$0.24 D_*^{-1}$
$4 < D_* \leq 10$	$0.14 D_*^{-0.64}$
$10 < D_* \leq 20$	$0.04 D_*^{-0.1}$
$20 < D_* \leq 150$	$0.013 D_*^{0.29}$
$D_* > 150$	0.055

Table 2.2 Shields curve as function of  $D_*$

The quantity  $\Delta$  is the relative density of sediment under water:  $\Delta = (\rho_s - \rho) / \rho$  (=1.65)

### **Hydraulic roughness for compound channels**

In the above it has been indicated that a clear relationship exists between bed features and the hydraulic roughness, whether it is expressed by  $k_s$  or Manning's  $n$ . In view of this it will be obvious that a combined value for  $k_s$  or  $n$  for a compound channel does not make sense. The values have to be determined/estimated for each segment separately to be of any value for rating curve extrapolation!

## **2.5 UNSTEADY FLOW**

The propagation and attenuation of flood waves in river systems are described by the following partial differential equations (see Volume 4, Reference Manual):

- Continuity equation:

$$\frac{\partial A}{\partial t} + \frac{\partial Q}{\partial x} = 0 \quad (2.33)$$

- Momentum equation:

$$\frac{1}{gA_s} \frac{\partial}{\partial x} \left( \frac{Q^2}{A_s} \right) + \frac{1}{gA_s} \frac{\partial Q}{\partial t} + \frac{\partial h}{\partial x} - S_0 + \frac{n^2 Q |Q|}{R^{4/3} A_s^2} = 0 \quad (2.34)$$

where:  $A$  = total cross-sectional area (conveying and storage areas)

$B$  = total width of cross-section

$A_s$  = cross-sectional area of conveying section

$B_s$  = width of conveying cross-section

$h$  = flow depth

$S_0$  = bottom slope

$n$  = Manning's hydraulic roughness parameter

$R$  = hydraulic radius of conveying cross-section

A definition sketch of the cross-section is shown in Figure 2.5. The above equations form the so-called Saint-Venant equations.

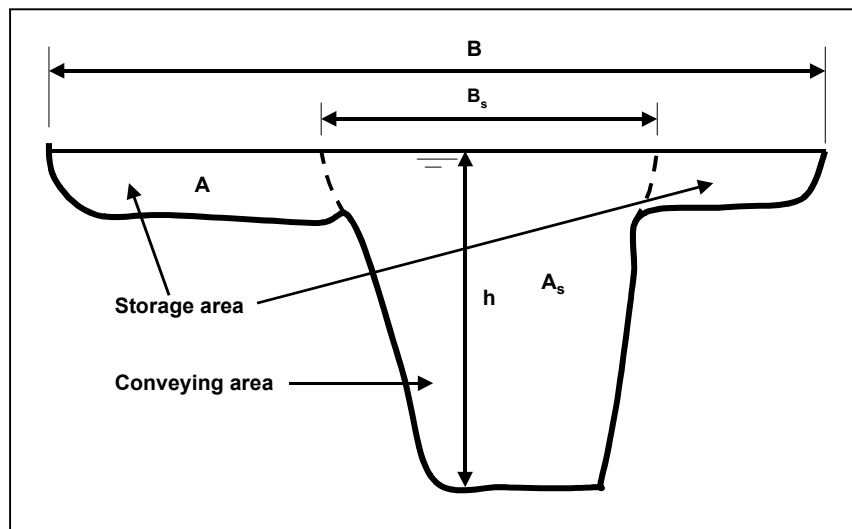

Figure 2.5:  
Definition sketch river  
cross-section

It can be shown, that, if the Froude number is small, the first two terms in (2.34), which represent convective and local acceleration effects, are negligible compared to  $\partial h/\partial x$ . Then, the momentum equation reduces to:

$$Q = \frac{1}{n} A_s R^{2/3} S_0^{1/2} \left( 1 - \frac{1}{S_0} \frac{\partial h}{\partial x} \right)^{1/2} \quad (2.35)$$

From (2.35) it is observed, that the bracketed term approaches 1 if  $\partial h/\partial x \ll S_0$ , and the momentum equation reduces to:

$$Q = \frac{1}{n} A_s R^{2/3} S_0^{1/2} \approx \frac{1}{n} B_s h^{5/3} S_0^{1/2} \quad (2.36)$$

The latter expression applies for wide rivers, where  $A_s \approx B_s h$  and  $R \approx h$ . Because of the condition  $\partial h/\partial x \ll S_0$  it follows that for unsteady flow (2.36) is typically only suited for steep rivers.

### **Flood wave celerity**

The celerity of a flood wave is given by:

$$c = \frac{dQ}{dA} \approx \frac{1}{B} \frac{dQ}{dh} \quad (2.37)$$

Differentiation of (2.36) with respect to  $h$  and substitution into (2.37) gives the following expression for the celerity of a flood wave or kinematic wave:

$$c \approx \frac{5}{3} \frac{B_s}{B} \bar{v} \quad (2.38)$$

From this it is observed that for a river without a flood plain, i.e.  $B_s = B$ , the flood wave moves faster than the average flow velocity. If, however,  $B \gg B_s$ , i.e. for a river with a wide flood plain, then the flood wave will move slower than the average velocity in the main river. Hence, it is observed that the flood wave celerity will change if the river flow changes from inbank to overbank.

### **Flood wave damping**

From the continuity equation (2.33) and the momentum equation (2.35) an approximate expression for the damping of a flood wave per unit distance can be derived:

$$\frac{dQ_{\max}}{dx} \approx \frac{D}{c^3} \frac{\partial^2 Q}{\partial t^2} \quad \text{where: } D = \frac{Q}{2BS_0} \Big|_{\text{at } Q_{\max}}$$

For a sinusoidal wave with amplitude  $a_0$  and duration/period  $T$  the wave damping becomes:

$$\frac{dQ_{\max}}{dx} \approx -4.3 \frac{n^2 (B/B_s)^2 a_0}{h^{1/3} S_0^2 T^2} \quad (2.39)$$

Equation (2.39) shows that the damping of a flood wave is large, if:

- Total width of river and flood plain is large compared to the river width
- Hydraulic roughness is large
- Slope of the riverbed is small
- The flood wave amplitude is large, and
- The duration of the flood wave is small.

Hence, the steeper the flood wave the stronger it attenuates.

### **Looped stage-discharge relation**

From equation (2.35) it is observed that for sub-critical flow there is no unique relationship between stage and discharge. Since  $\partial h/\partial x < 0$  for the rising stage and  $> 0$  thereafter, it is seen that for equal stages the discharge is larger when the flow is rising than when the flow is falling. Since the rate of rise is generally larger than the rate of fall the actual stage-discharge relation will behave asymmetrical about the steady state rating curve. Because the slope of the water table is difficult to monitor, by making use of the continuity equation (2.33) and (2.37)  $\partial h/\partial x$  is replaced by  $-1/c \cdot \partial h/\partial t$ , which is measurable from the hydrograph observed at one station. Equation (2.35) then evolves to the so-called Jones-equation, which reads:

$$Q = \frac{1}{n} B_s h^{5/3} S_0^{1/2} \sqrt{1 + \frac{1}{S_0 c} \frac{\partial h}{\partial t}} = Q_s \sqrt{1 + \frac{1}{S_0 c} \frac{\partial h}{\partial t}} \quad (2.40)$$

where:  $Q_s$  = steady uniform flow.

The looped stage discharge relation is shown in Figure 2.6.

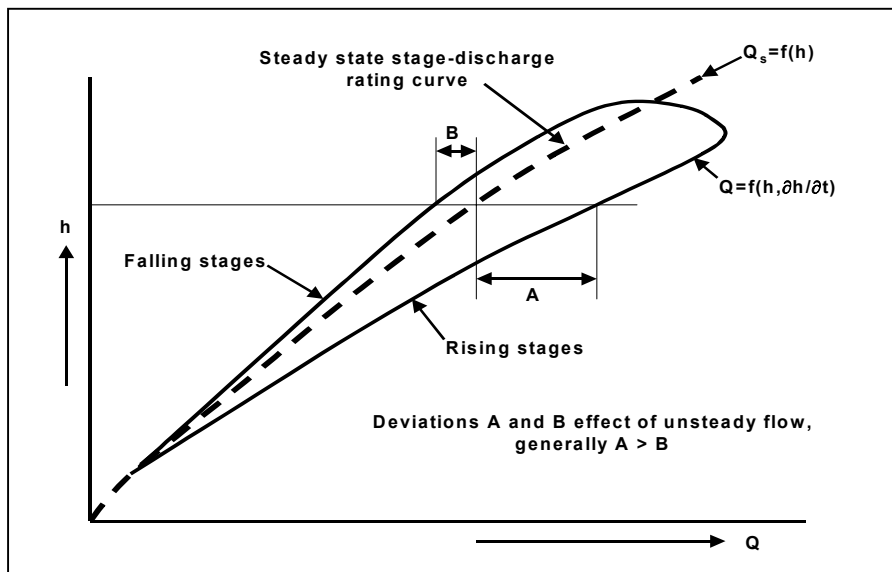

Figure 2.6: Effect of unsteady flow on stage-discharge relationship

## 2.6 BACKWATER CURVES

Downstream tributaries, deltas, coasts, reservoirs, lakes, structures and aquatic vegetation growth can all cause variable backwater effects which can effect the stability and reliability of the stage-discharge relationship. Such effects should be avoided, if possible, during the site selection process. If a site is upstream of a reservoir or some other downstream influence it is possible using one of the following methods to obtain an initial estimate of the possible impact of backwater. A decision can then be made whether the site under consideration would be better located further upstream. The terms used in the method are illustrated in Figure 2.7 below.

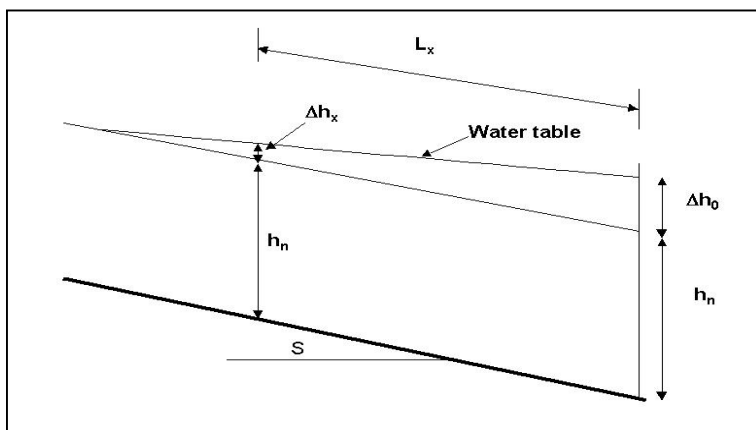

Figure 2.7: Definition sketch for backwater effect

To estimate the extent of backwater some simple procedures are introduced here for a rapid assessment. For a more detailed treatise reference is made to Volume 4, Reference Manual, Hydrometry.

To describe the backwater curve use is made of the Bélanger equation, which reads:

$$\frac{dh}{dx} = S_0 \frac{h^3 - h_n^3}{h^3 - h_c^3} \tag{2.41}$$

where:  $h_n$  = normal, equilibrium or uniform flow depth, from (2.36)

$h_c$  = critical flow depth at the transition from sub-critical to super-critical flow ( $Fr = 1$ ), from (2.4)

- **Equilibrium or normal flow depth  $h_n$ :**

$$h_n = \left( \frac{nq}{S_0^{1/2}} \right)^{3/5} \quad (2.42)$$

where:  $q$  = discharge per unit width =  $Q/B_s = vh$

$n$  = Manning's hydraulic roughness parameter

$S_0$  = bed slope of the river

- **Critical flow depth  $h_c$ :**

$$h_c = \left( \frac{q^2}{g} \right)^{1/3} \quad (2.43)$$

For given  $q$ ,  $S_0$  and  $n$ ,  $h_n$  and  $h_c$  are known quantities. So, (2.41) is an ordinary differential equation in  $h$ .

***Approximation of backwater effect***

Assuming a gradually varied flow M1 type profile and a wide rectangular cross-section, a first order estimate of the extent of backwater is obtained from:

$$\Delta h_x \approx \Delta h_0 \exp\left( \frac{-3S_0 L_x}{h_n(1 - Fr^2)} \right) \quad \text{for : } \Delta h_0 \ll h_n \quad (2.44)$$

where:  $\Delta h_x$  = backwater effect at  $x = L_x$

$\Delta h_0$  = initial set up of water level at  $x = 0$

$S_0$  = river bottom slope

$L_x$  = distance

Note that this estimate applies for  $\Delta h_0 \ll h_n$ . A crude order of magnitude for the distance over which the backwater is felt, is obtained from:

$$L_x \approx \frac{h_n}{S_0} \quad (2.45)$$

For a compound cross-section in which river (r) and floodplain (f) both convey part of the total discharge,  $h_n$  in (2.22) and (2.45) is to be replaced by  $h_E$ :

$$h_E = \left( \frac{B_r h_r^{3/2} + B_f h_f^{3/2}}{B_r h_r + B_f h_f} \right)^2$$

This equation holds well if the roughness in the river and the flood plain does not differ much.

***estimation by Bresse function***

For more accurate computations one can apply the Bresse function. For a wide river the set of equations to solve read (Chow, 1959):

$$L_x = -\frac{h_n}{S} [(\eta_x - \eta_0) - \gamma\{\psi(\eta_x) - \psi(\eta_0)\}] \tag{2.46}$$

where :

$$\eta_x = \frac{\Delta h_x + h_n}{h_n} \quad ; \quad \eta_0 = \frac{\Delta h_0 + h_n}{h_n} \quad ; \quad \gamma = 1 - Fr^2$$

and

$$\psi(\eta) = \frac{1}{6} \ln \left\{ \frac{\eta^2 + \eta + 1}{(\eta - 1)^2} \right\} - \frac{1}{\sqrt{3}} \operatorname{arc cot} g \left\{ \frac{2\eta + 1}{\sqrt{3}} \right\}$$

The function  $\Psi(\eta)$  for  $1 \leq \eta < 1.25$  is presented in Table 2.3. An application is presented in Example 2.1.

$\eta$	$\Psi$	$\eta$	$\Psi$	$\eta$	$\Psi$	$\eta$	$\Psi$	$\eta$	$\Psi$
1.000	$\infty$	1.050	0.896	1.100	0.681	1.150	0.561	1.200	0.480
1.001	2.184	1.051	0.889	1.101	0.678	1.151	0.559	1.201	0.478
1.002	1.953	1.052	0.883	1.102	0.675	1.152	0.557	1.202	0.477
1.003	1.818	1.053	0.877	1.103	0.672	1.153	0.555	1.203	0.476
1.004	1.723	1.054	0.871	1.104	0.669	1.154	0.553	1.204	0.474
1.005	1.649	1.055	0.866	1.105	0.666	1.155	0.551	1.205	0.473
1.006	1.588	1.056	0.860	1.106	0.663	1.156	0.550	1.206	0.472
1.007	1.537	1.057	0.854	1.107	0.660	1.157	0.548	1.207	0.470
1.008	1.493	1.058	0.849	1.108	0.657	1.158	0.546	1.208	0.469
1.009	1.454	1.059	0.843	1.109	0.655	1.159	0.544	1.209	0.468
1.010	1.419	1.060	0.838	1.110	0.652	1.160	0.542	1.210	0.466
1.011	1.388	1.061	0.833	1.111	0.649	1.161	0.541	1.211	0.465
1.012	1.359	1.062	0.828	1.112	0.647	1.162	0.539	1.212	0.464
1.013	1.333	1.063	0.823	1.113	0.644	1.163	0.537	1.213	0.463
1.014	1.308	1.064	0.818	1.114	0.641	1.164	0.535	1.214	0.461
1.015	1.286	1.065	0.813	1.115	0.639	1.165	0.534	1.215	0.460
1.016	1.264	1.066	0.808	1.116	0.636	1.166	0.532	1.216	0.459
1.017	1.245	1.067	0.804	1.117	0.634	1.167	0.530	1.217	0.458
1.018	1.226	1.068	0.799	1.118	0.631	1.168	0.528	1.218	0.456
1.019	1.208	1.069	0.795	1.119	0.628	1.169	0.527	1.219	0.455
1.020	1.191	1.070	0.790	1.120	0.626	1.170	0.525	1.220	0.454
1.021	1.175	1.071	0.786	1.121	0.624	1.171	0.523	1.221	0.453
1.022	1.160	1.072	0.781	1.122	0.621	1.172	0.522	1.222	0.451
1.023	1.146	1.073	0.777	1.123	0.619	1.173	0.520	1.223	0.450
1.024	1.132	1.074	0.773	1.124	0.616	1.174	0.519	1.224	0.449
1.025	1.119	1.075	0.769	1.125	0.614	1.175	0.517	1.225	0.448
1.026	1.106	1.076	0.765	1.126	0.612	1.176	0.515	1.226	0.447
1.027	1.094	1.077	0.760	1.127	0.609	1.177	0.514	1.227	0.445
1.028	1.082	1.078	0.756	1.128	0.607	1.178	0.512	1.228	0.444
1.029	1.071	1.079	0.753	1.129	0.605	1.179	0.511	1.229	0.443
1.030	1.060	1.080	0.749	1.130	0.602	1.180	0.509	1.230	0.442
1.031	1.049	1.081	0.745	1.131	0.600	1.181	0.507	1.231	0.441
1.032	1.039	1.082	0.741	1.132	0.598	1.182	0.506	1.232	0.440
1.033	1.029	1.083	0.737	1.133	0.596	1.183	0.504	1.233	0.438
1.034	1.019	1.084	0.734	1.134	0.594	1.184	0.503	1.234	0.437
1.035	1.010	1.085	0.730	1.135	0.591	1.185	0.501	1.235	0.436
1.036	1.001	1.086	0.726	1.136	0.589	1.186	0.500	1.236	0.435
1.037	0.992	1.087	0.723	1.137	0.587	1.187	0.498	1.237	0.434
1.038	0.983	1.088	0.719	1.138	0.585	1.188	0.497	1.238	0.433
1.039	0.975	1.089	0.716	1.139	0.583	1.189	0.495	1.239	0.432
1.040	0.967	1.090	0.713	1.140	0.581	1.190	0.494	1.240	0.431
1.041	0.959	1.091	0.709	1.141	0.579	1.191	0.492	1.241	0.429
1.042	0.951	1.092	0.706	1.142	0.577	1.192	0.491	1.242	0.428
1.043	0.944	1.093	0.703	1.143	0.575	1.193	0.490	1.243	0.427
1.044	0.936	1.094	0.699	1.144	0.573	1.194	0.488	1.244	0.426
1.045	0.929	1.095	0.696	1.145	0.571	1.195	0.487	1.245	0.425
1.046	0.922	1.096	0.693	1.146	0.569	1.196	0.485	1.246	0.424
1.047	0.915	1.097	0.690	1.147	0.567	1.197	0.484	1.247	0.423
1.048	0.909	1.098	0.687	1.148	0.565	1.198	0.483	1.248	0.422
1.049	0.902	1.099	0.684	1.149	0.563	1.199	0.481	1.249	0.421

Table 2.3: The function  $\Psi(\eta)$  for  $1 \leq \eta < 1.25$

**Example 2.1 Application of Bresse function**

The distance is to be determined over which the backwater effect at  $x = 0$  of 1 m is reduced to 5% of its original value for a river with a bed slope of  $5 \times 10^{-4}$ , hydraulic roughness  $n = 0.03$ , when the normal depth  $h_n = 5$  m.

1. Determination of  $\eta$  and  $\Psi(\eta)$

For  $x = 0$  the backwater is  $\Delta h_0 = 1$  m hence  $\eta_0$  becomes:

$$\eta_0 = \frac{\Delta h_0 + h_n}{h_n} = \frac{1.0 + 5.0}{5.0} = 1.20$$

If  $x = x_1$  is the distance at which the initial backwater effect is reduced to 5% of its value:  $\Delta h_1 = 0.05$  m, hence  $\eta_1$  becomes:

$$\eta_1 = \frac{\Delta h_1 + h_n}{h_n} = \frac{0.05 + 5.0}{5.0} = 1.01$$

It then follows for  $\Psi(\eta_0)$  and  $\Psi(\eta_1)$  from Table 2.3:  $\Psi(\eta_0) = 0.480$  and  $\Psi(\eta_1) = 1.419$

2. Froude correction  $\gamma$ :

$$\gamma = 1 - Fr^2 = 1 - \frac{v^2}{gh} = 1 - \frac{h_n^{1/3} S_0}{gn^2} = 1 - \frac{5^{1/3} \times 5 \times 10^{-4}}{9.81 \times 0.03^2} = 0.903$$

The parameter  $\gamma$  in equation (2.46) follows from:

3. Computation of  $L_x$

The distance  $L_x = x_1 - x_0$  follows from (2.46) by substitution of the values determined under 1 and 2:

$$L_x = -\frac{h_n}{S_0} [(\eta_1 - \eta_0) - \gamma \{\Psi(\eta_1) - \Psi(\eta_0)\}] = -\frac{h_n}{S_0} [(1.01 - 1.2) - 0.903 \times (1.419 - 0.480)] = 1.038 \times \frac{h_n}{S_0} = 10,380 \text{ m} = 10.4 \text{ km}$$

Note that the distance is only 4% larger than one would have obtained from (2.45). The results ( $L_x$  at 5% of the original value, expressed as a function of  $h_n/S_0$ ) for different river slopes and roughness values for the same normal depth (5 m) and initial backwater (1 m) are presented in the following table:

$S_0$	Froude parameter $\gamma$			$L_x$ expressed as function of $h_n/S_0$		
	Roughness $n$			Roughness $n$		
	0.025	0.03	0.05	0.025	0.03	0.05
$1 \times 10^{-3}$	0.721	0.806	0.930	0.867	0.947	1.063
$5 \times 10^{-4}$	0.861	0.903	0.965	0.998	1.038	1.096
$1 \times 10^{-4}$	0.972	0.981	0.993	1.103	1.111	1.122

It is observed, that the multiplier to  $h_n/S_0$ , to arrive at  $L_x$ , is close to 1 for different river slopes and roughness values. Adding some 10% to the value for  $L_x$  obtained from (2.45) will give a reasonable approximation of the extent of the backwater reach in practice for field applications.



## 3 HYDROMETRIC NETWORK DESIGN

### 3.1 INTRODUCTION

A hydrometric network is a system of river gauging stations in a river basin at which river stage and discharge are measured. The network provides hydrologic data needed for the planning, design and management of conservation and utilisation of the waters and other natural resources of the river system. In flood prone areas the network may also provide data for design and management of flood protection measures. The data should enable accurate estimation of the relevant characteristics of the hydrological regime of the river basin. The network requirement is greatly influenced by a number of factors including:

- monitoring objectives, determined by the data needs of the hydrological data users
- temporal and spatial variability of the river flow, determined by:
  - climatic features like precipitation pattern in the catchment, evapo(transpi)ration
  - physiographic features of the river basin, like size, slope, shape, soils, land use and drainage characteristics
- the availability of financial, manpower and other resources.

The identification of the monitoring objectives is the first step in the design and optimisation of the monitoring systems. Related to this is the identification of the potential data users and their future needs. Reference is made to Chapter 3 of Volume 1 of the Design Manual on Hydrological Information System for a summary. The actual data need for a particular basin is to be obtained by interviewing the potential hydrological data users, to be presented in a Hydrological Information Need (HIN) document, where in case of more objectives, priorities are indicated.

The second variable to be considered in the design of the hydrometric network is the dynamics of the river flow and stages in time and space. This requires a critical analysis of historical data.

To enable an optimal design of the monitoring system a measure is required, which quantifies the effectiveness level. This measure depends on the monitoring objectives and can be related to an admissible error in e.g. the mean flow during a certain period, monthly flow values for water balances, extreme flows and/or river stages, etc. This error is a function of the sampling locations, sampling frequency and sampling accuracy, i.e. where, when and with what are river/reservoir stages and flows to be measured.

Reference is made to Chapter 7 of Volume 2 of the Design Manual on Sampling Principles for an introduction into the general principles of network design and optimisation. In this volume the principles are tuned to the hydrometric network. It is, however, stressed that the hydrometric network should never be considered in isolation. The network is part of an integrated system of networks of the HIS including also hydro-meteorology, geo-hydrology and water quality. The totality of the networks should provide the data requested for by the Hydrological Data Users.

In this chapter the following topics are discussed:

- general hydrometric network design considerations,
- network density, and
- network design process.

---

## 3.2 NETWORK DESIGN CONSIDERATIONS

In this section a number of aspects are discussed to be considered before actually designing the hydrometric network, including:

- Classification of stations,
- Minimum networks,
- Networks for large river basins,
- Networks for small river basins,
- Networks for deltas and coastal flood plains,
- Representative basins,
- Sustainability,
- Duplication avoidance, and
- Periodic re-evaluation.

### 3.2.1 CLASSIFICATION

Based on the network levels presented in Sub-section 7.2 of Volume 2, Design Manual, Sampling Principles the following classification of stations is introduced:

**Primary stations**, maintained as key stations, principal stations or bench mark stations, where measurements are continued for a long period of time to generate representative flow series of the river system and provide general coverage of a region.

**Secondary stations**, which are essentially short duration stations intended to be operated only for such a length of period, which is sufficient to establish the flow characteristics of the river or stream, relative to those of a basin gauged by a primary station.

**Special purpose stations**, usually required for the planning and design of projects or special investigations and are discontinued when their purpose is served. The purpose could vary from design, management and operation of the project to monitoring and fulfilment of legal agreements between co-basin states. The primary as well as secondary stations may also, in time serve as special purpose stations.

In designing a network all types of stations must be considered simultaneously.

### 3.2.2 MINIMUM NETWORKS

A minimum network should include at least one primary streamflow station in each climatological and physiographic area in a State. A river or stream, which flows through more than one State, should be gauged at the State boundary. At least one primary gauging station should also be established in those basins with potential for future development.

A minimum network should also include special stations. Where a project is of particular socio-economic importance to a State or Region it is essential that a gauging station is established for planning, design and possibly operational purposes. Sometimes special stations are required to fulfil a legal requirement e.g. the quantification of compensation releases or abstraction controls. Benefit - cost ratios for special stations are usually the highest and can help support the remainder of the hydrometric network.

### 3.2.3 NETWORKS FOR LARGE RIVER BASINS

A **primary station** might be planned at a point on the main river where the mean discharge attains its maximum value. For rivers flowing across the plains, this site is usually in the downstream part of the river, immediately upstream of the point where the river normally divides itself into branches before joining the sea or a lake or crosses a State boundary. In the case of mountainous rivers, it is the point where water leaves the mountainous reach and enters the plain land. Subsequent stations are established at sites where significant changes in the volume of flow are noticed viz., below the confluence of a major tributary or at the outflow point of a lake etc.

If a suitable location is not available below a confluence, the sites can be located above the confluence, preferably on the tributary. While establishing sites downstream of a confluence, care should be taken to ensure that no other small stream joins the main river so as to avoid erroneous assessment of the contribution of the tributary to the main river. In the case of a large river originating in mountains, though the major contribution is from upper regions of the basin, several stations may have to be located in the downstream stretch of the river. Such stations are intended to provide an inventory of water loss from the channel by way of evaporation, infiltration, and by way of utilisation for irrigation, power generation, industrial and other domestic needs.

The distance between two stations on the same river may vary from thirty to several hundred kilometres, depending on the volume of flow. The drainage areas computed from origin up to consecutive observation sites on a **large river should preferably differ by more than 10% so that the difference in quantities of flow is significant**. The uncertainties in discharge values particularly for high flows are unlikely to be less than +/- 10%. However, every reasonable attempt should be made to minimise these uncertainties.

The above uncertainties may affect the location of stations. When tributary inflow is to be known it is generally better to gauge it directly, rather than deriving the flow from the difference of a downstream and an upstream station along the main stream (see Volume 2, Design Manual, Chapter 4, Example 4.1). Also, a more accurate discharge record for the main stream is obtained from monitoring the feeder rivers than by a main stream station alone, however, at the expense of additional cost.

### 3.2.4 NETWORKS FOR SMALL RIVER BASINS

The criteria mentioned in Sub-section 3.2.3 are applicable to a river basin having a large area and well developed stream system. A different approach is to be adopted in dealing with small independent rivers, which flow directly into the sea, as in the case of west flowing rivers of Kerala and Maharashtra and some east flowing rivers of Tamil Nadu. In such cases, the first hydrological observation station might be established on a stream that is typical of the region and then further stations could be added to the network so as to widely cover the area. Streams in a particular area having meagre or lower yields should not be avoided for inclusion in the network. Absence of a station on a low flow stream may lead to wrong conclusions on the water potential of the area as a whole, evaluated on the basis of the flow in the high flow streams. Thus, great care is to be exercised in designing the network to ensure that all distinct hydrologic areas are adequately covered. It is not possible to operate and maintain gauging stations on all the smaller watercourses in the Western Ghats, for example. Therefore, representative basins have to be selected and the data from those are used to develop techniques for estimating flows for similar ungauged sites.

### 3.2.5 NETWORKS FOR DELTAS AND COASTAL FLOODPLAINS

Deltaic areas such as the Lower Mahanadi in Orissa, where gradients are usually low and channels bifurcate, are often important, as water use is productive and thus these areas need monitoring. This is particularly important, as deltas are dynamic systems, i.e. they are continually changing. However, the type of network required may differ from more conventional river basins. It is often not possible due to the low gradients to locate stations with stable stage-discharge relationships, i.e. variable backwater effects can occur due to tidal influences and/or changes in aquatic vegetation growth.

Stage readings should be made at all principal off-takes/bifurcations or nodes in the system. These should be supplemented by current meter gaugings when required. At some sites consideration might be given to installing a slope-area method station.

### 3.2.6 REPRESENTATIVE BASINS

When gauging stations are included in a network to obtain representative data from a particular physiographic zone, it is better if the chosen basins are those with the water resource relatively under utilised, i.e. the basins can be considered to be close to their natural state. The selection of representative gauging stations in basins, which are heavily utilised by dams and water abstraction and/or where significant land use changes have and are continuing to take place should be avoided.

### 3.2.7 SUSTAINABILITY

Of paramount importance is **sustainability**. It is a relatively straightforward task to design a dense network of streamflow stations. However, the implementation and operation of a network is a lot more difficult. It has been found from experience, that there is a tendency to adopt an idealistic approach and attempt to have as many stations as possible. There are many examples of networks throughout the world, which are no longer functioning well due to lack of financial support, skilled manpower and logistic support resources such as vehicles. It is far better to operate and maintain 10 gauging stations well than to operate and maintain 20 stations badly i.e. higher quality data from fewer stations is preferable to a lower quality of data from a greater number of stations.

### 3.2.8 DUPLICATION AVOIDANCE

Since, generally more than one organisation is responsible for the establishment of gauging stations e.g. the State Water Departments and CWC, **it is essential that the activities are co-ordinated so they complement each other and duplication of effort is avoided.**

### 3.2.9 PERIODIC RE-EVALUATION

Gauging station networks require **periodic re-evaluation**. The developments that take place in the basin, like construction of new irrigation/hydro-electric projects and industrialisation of the area, may warrant addition or closure of stations. For example river reaches are often polluted due to the discharge of effluents from industry. Therefore, a need may arise to establish stations to assist with water quality monitoring and pollution assessments.

## 3.3 NETWORK DENSITY

The World Meteorological Organisation developed guidelines on minimum hydrological network densities. Their guidelines and potential use and limitations are presented in this section. Furthermore, a prioritisation system is introduced to rank the importance of stations. Finally, comments are given on the use of statistical and mathematical optimisation techniques for hydrometric networks.

### 3.3.1 WMO RECOMMENDATIONS

The recommendations of the WMO (World Meteorological Organisation) on the minimum density of a streamflow network for regions with different physiographic features are reproduced in Table 3.1 below.

	Type of region	Range of norms for minimum network	Range of provisional norms tolerated in <sup>1</sup> difficult conditions
I.	Flat regions	1,000 - 2,000	3,000 - 10,000
II.	Mountainous regions	300 - 1,000 <sup>2</sup>	1,000 - 5,000
III.	Arid zones <sup>3</sup>	5,000 <sup>4</sup> - 20,000	-----

## NOTES:

1. Last figure in the range should be tolerated only for exceptionally difficult conditions;
2. Under very difficult conditions this may be extended up to 10000 km<sup>2</sup>;
3. Great deserts are not included;
4. Under very difficult conditions this may be extended up to 10000 km<sup>2</sup>.

Table 3.1: Minimum density of hydrological network according to WMO, area in km<sup>2</sup> for one station

It is not possible to provide specific, general guidelines on an appropriate network density. The WMO recommendations are very general guidelines which if adopted at face value for some of India's larger river basins could result in an excessively dense network. **Even though the WMO type guidelines might be used as rough rule of thumb as part of an initial network appraisal, their use in the final design of the network should be avoided.** The network density must ultimately be based on the network objectives, the temporal and spatial variability of river stages and flow and on the availability of finance, manpower and other resources.

### 3.3.2 PRIORITISATION SYSTEM

It is suggested that in the first instance the "ideal" network size is determined. In determining the network all potential users of the data should be consulted. Each station in the "ideal" network should be prioritised. In order to do this a simple prioritisation system is useful. This prioritisation system could be a simple one such as follows:

Category	Priority	Relative Importance
A	High	Major, multi-purpose water resources development site, State boundary river, operation of major scheme, major ungauged basin, heavily polluted major water supply source
B	Medium	Medium scale water resources development project site, secondary basin, industrial development area, i.e. potential water quality problems)
C	Low	Minor irrigation project site, secondary gauging station on tertiary tributary, major water course but already extensively gauged

The above categories and priorities are merely highlighted by way of example. Each State/Central organisation needs to set its own priorities based on its own policies and objectives. In prioritising sites, the following questions should be asked:

What are the socio-economic consequences of not collecting streamflow data at the site?

What are the alternatives to establishing a streamflow gauging station at the site under consideration?

An estimate of the number of stations within each State, Division and Sub-division which can be realistically well maintained should be made. When deriving this estimate, the following factors should be considered:

- The recurrent budget implications;
- Short and longer term manpower requirements and availability of suitably skilled personnel;
- Capacity of instrument repair, spare part provision and calibration facilities;
- Long term availability of logistic support facilities such as vehicles.

---

The ideal and realistic network size estimates should be compared. If necessary the size of the ideal network should then be reduced by removing the lower priority stations.

### 3.3.3 STATISTICAL AND MATHEMATICAL OPTIMISATION

The streamflow network should provide information for the location indicated by the hydrological data users. At a number of locations no stations will be available. Hence the information is to be obtained from the network by e.g. interpolation. If the interpolation error in estimating a flow characteristic is too large than additional stations or a re-design should be considered. These techniques are most applicable to already well established networks, where the data have been rigorously quality controlled and are readily available in computer compatible form. However, they are less readily applied to heavily utilised, over-regulated catchments like many of the larger river basins in India. These techniques are a tool to assist with network design. They are not straightforward to apply and do not totally obviate the need for the pragmatic, common sense approach.

## 3.4 THE NETWORK DESIGN PROCESS

Since everywhere hydrometric networks are existing, the network design process is one of evaluation, reviewing and updating of an existing network. The historic evolution of many hydrometric networks has tended to be **reactively** rather than **strategically** planned. Often gauging stations are being operated for which the original objectives are unclear. It is therefore necessary to regularly undertake a detailed review of the existing networks to achieve the following:

- Define and/or re-define the purpose of each gauging station;
- Identify gaps in the existing network;
- Identify stations which are no longer required;
- Establish a framework for the continual evaluation and updating of the network.

There is a tendency for hydrometrists, hydrologists and water resources planners to be reluctant to discontinue gauging stations, even though they might have fulfilled their intended objectives. In the design and evaluation of networks it is essential that a **'hard nosed' approach** is adopted and stations which are no longer providing a significant benefit are discontinued.

In Chapter 7 of Volume 2, Design Manual, Sampling Principles a list of steps is presented to be carried out for the review and redesign design of a network. Specific steps for the review of the hydrometric network are outlined in Part I of Volume 4, Field Manual, Hydrometry. The main steps in the network design process can be summarised as follows:

1. Review mandates, roles and aims of the organisations involved in the operation of the HIS in a particular area and evaluate the communication links.
2. Collect maps and other background information.
3. Define the **purposes** of the network: - who are the data users and what will the data be used for? Define the **objectives** of the network: - what type of data is required where and at what frequency?
4. Evaluate the existing network: - How well does the existing network meet the overall objectives?
5. Review existing data to identify gaps, ascertain catchment behaviour and variability.
6. Identify gaps and over-design in the existing network: Propose new stations and delete existing stations where necessary, i.e. revise the network.
7. Prioritise gauging stations: i.e. try to use some simple form of classification system.

- 
8. Estimate average capital and recurrent costs of installing and maintaining different categories of hydrometric stations. Estimate overall cost of operating and maintaining the network.
  9. Review the revised network in relation to overall objectives, ideal network, available budgets and the overall benefits of the data. Investigate the sustainability of the proposed network.
  10. Prepare a phased implementation plan. This has to be prioritised, realistic and achievable.
  11. Decide on the approximate location of sites, commence site surveys. If a site is not available review the location and see if another strategy can be adopted, e.g. gauge a tributary to estimate total flow at the required spot rather than trying to measure the total flow in the main stem river. Guidelines on site selection are contained in Chapter 4.
  12. Establish a framework for regular periodic network reviews.

As hydrometric network design is a dynamic process, networks have to be continually reviewed and updated so that they react to new priorities, changes in policies and fiscal changes. Regular formalised network reviews should be undertaken, recommended to take place after 3 years or at a shorter interval if new data needs do develop.

## 4 SITE SELECTION OF WATER LEVEL AND STREAMFLOW STATIONS

### 4.1 DEFINITION OF OBJECTIVES

Prior to embarking on the selection of a water level (stage) monitoring or streamflow-gauging site, it is imperative that the objectives of the site are fully defined. In this regard the following factors have to be established:

1. What is the purpose of the station? E.g. planning and design of major water supply scheme, pollution monitoring, flood forecasting, etc.
2. Define the required location of the site, i.e. what are the most upstream and downstream limits; e.g. the station might have to be located between two major tributaries.
3. Does the full flow range require monitoring or are low or high flows of greater importance?
4. What level of accuracy is required?
5. What period of record is required and what frequency of measurement is desirable?
6. Who will be the beneficiaries of the data?
7. Is a particular streamflow measurement methodology or instrument preferred?
8. Are there any constraints such as access and land acquisition problems and cost limitations?

The activities involved in selection of a site are dealt with in Section 4.3. The selection of water level gauging and discharge measuring sites are discussed in respectively Sections 4.4 and 4.5. The selection of a streamflow measuring site requires a proper understanding of the various types of controls; an overview is presented in Section 4.2.

### 4.2 DEFINITION OF CONTROLS

#### *Terminology*

The shape, reliability and stability of the stage-discharge relationship are normally controlled by a section or reach of channel at, or downstream of the gauging station, which is known as a **control**. In terms of open channel hydraulics a control is generally termed a **section control** if critical flow occurs a short distance downstream from the gauging station. This can occur where a natural constriction or a downward break in channel slope occurs resulting from a rock outcrop or a local constriction in width caused by the construction of a bridge. If the stage-discharge relationship depends mainly on channel irregularities and friction downstream of the station then this is referred to as a **channel control**. This is the most common type of control in India. A **complete control** is one which determines the stage-discharge relationship throughout the complete range of flow e.g. at a high waterfall. However, more commonly no single control is effective for the entire range and we then have a **compound control**. This could be a combination of a section control at low stages and channel control for high stages. A control is permanent if the stage-discharge relationship it defines does not change with time, otherwise it is referred to as a **shifting control**.

Controls can either be **natural** or **artificial** (man made for flow measurement purposes). **Artificial controls** may be purpose built flow measurement structures, which have a theoretical stage - discharge relationship unique to the structure. As such it is not necessary to undertake a large number of current meter gaugings in order to define the stage - discharge relationship. However, the



theoretical relationships should be checked over the full range of flows. Reservoir spillways, control weirs and anicuts frequently come into the 'artificial' category, even though they have not been purpose built for flow measurement purposes, since it is often possible to derive theoretical stage-discharge relationships. Structures, which have not been constructed for the purpose of flow measurement such as bridges, floodway channels and drifts, are not considered as artificial controls since they normally require full calibration.

Stage - discharge gauging stations such as natural controls and non-purpose built structures, which require current meter gauging to define the stage-discharge relationship are often referred to as **rated sections**.

The two most important attributes of a control are **stability** and **sensitivity** (the two "S"s). If the control is stable the stage-discharge relation will be stable. It is also important that the control is sensitive, i.e. small changes in water level should correspond to relatively small changes in discharge.

### ***Hydrometric sensitivity***

It is a primary requirement for stage-discharge gauging stations that the rating relationship should be as sensitive over as wide a range of flows as possible. In other words, any change in the recorded water level should correspond to a relatively limited (in percentage rather than absolute terms) change in flow. This is illustrated by the rating curves sketched below, see Figure 4.1. From this sketch it can be seen, that rating 1 is more sensitive than rating 2.

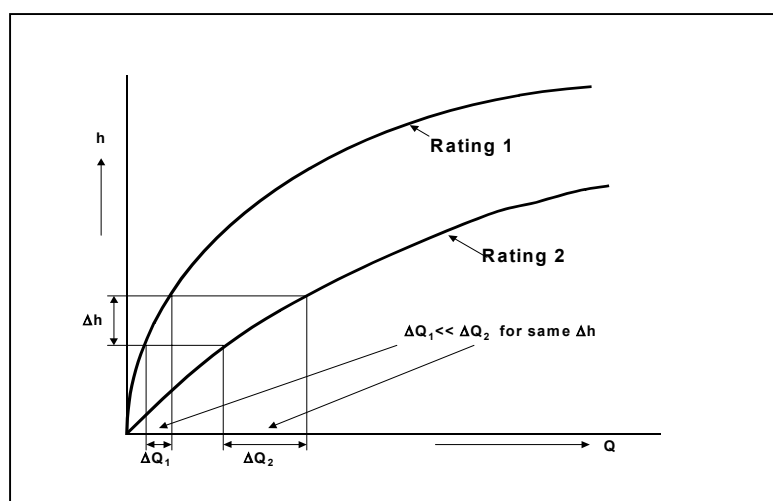

*Figure 4.1:  
Sketch illustrating the concept of  
hydrometric sensitivity*

## **4.3 SITE SURVEYS**

Once the purpose and objectives have been defined and the engineer responsible has considered what flow measurement and automatic water level recording techniques could be suitable, the site selection process can begin. The final choice of site will depend on the type and quality of the data required, the method to be deployed and other factors such as logistics and budgetary constraints. In particular the final site selection might be mainly determined by the choice of the most appropriate equipment or technique. Therefore, some guidance is provided in Chapter 6, on the advantages and limitations of different hydrometric methods used in, or which are suitable for Indian conditions.

In order to select the most appropriate site, considerable effort needs to be expended undertaking site selection surveys. The site selection surveys can be divided into four distinct phases, which are summarised in the sub-sections below:

1. Desk study
2. Reconnaissance surveys
3. Topographic surveys, and
4. Other survey work

To ensure that all the pertinent information is obtained during the site selection process and surveys and to assist with the work, a standard form has been prepared. This list has been derived from the CWC checklist. A copy of this form is contained in Appendix 2.1 of Chapter 2, Volume 4, Field Manual, Hydrometry.

### ***Desk study***

The target location for the gauging station will have already been identified on a 1:250,000 map or similar during the network design process. However, this size of map is too small a scale for site selection purposes. The inspection of large-scale topographic maps (1:50,000) and aerial photographs, if these are available, should be undertaken to identify possible sites within the target river reach.

### ***Reconnaissance surveys***

These should be undertaken by road, foot and for larger, navigable rivers by boat. It is important that the entire target reach of the river is inspected. During the survey, interviews should be held with local people to try and build up a picture of the local site conditions such as water level ranges. At sites of interest attempts could be made to ascertain who owns the land.

### ***Topographic surveys***

On completion of the reconnaissance surveys, one or more sites could have been identified which are worthy of further consideration. However, it is often not possible to make final decisions on site selection without the benefit of bed surveys. Cross-sectional surveys upstream and downstream of the gauging site have to be carried out to get a detailed picture of the approach conditions and of the layout and extent of the control section. Longitudinal profiles are to be obtained to assess the bed slope and to identify potential controls. Possible backwater sources have to be identified.

### ***Other survey work***

It is useful to carry out flow measurements and stage observations at locations near to the proposed site(s) prior to making the final site selection. From such measurements some idea will be obtained about the velocity distribution across the measuring cross-section, water level variation and water surface slope. If structures are to be installed it is possible that soils and geological surveys will be required to establish the stability of the banks and bed for founding the structure and the availability of construction material such as rip-rap.

### ***Summing up***

Once the surveys have been carried the following aspects have to be reviewed:

- technical aspects: the hydraulic suitability of the site,
- logistical aspects: site accessibility, communication and staffing,
- security aspects: security of instruments, away from residential areas and play grounds,
- legal aspects: land acquisition and right of passage, and
- financial aspects, including costs of land acquisition, civil works, equipment, data processing, and staffing and training.

#### 4.4 SELECTION OF WATER LEVEL GAUGING SITES

Stage measurements are most commonly required in surface water hydrometry to determine the flow using relationships between stage and discharge or cross-sectional area and velocity. Therefore, in many circumstances the selection of a stage or water level measurement site will be to a certain extent governed by the suitability of the site for flow measurement purposes. It is very important that extreme care is given to the selection of the location of stage monitoring devices since this is the basic raw data, which is required to derive discharge. Also, in some situations, flow estimates will not be required but it is necessary to measure water level only, e.g. in reservoirs, for flood warning.

The gauging site should be located outside high turbulence zones, close to the edge of the stream at a place where the banks are stable and preferably steep. The downstream control shall be stable and sensitive to be able to establish a stable stage-discharge relation, where significant changes in the discharge create significant changes in stage. The site shall be outside the backwater zone of confluences and structures. The extent of the backwater reach  $L$  is approximately (see Chapter 2):

$$L \approx \frac{h_n}{S} \quad (4.1)$$

where:  $L$  = approximate reach of the backwater effect  
 $h_n$  = normal or equilibrium depth (to be replaced by  $h_E$  for a compound cross-section)  
 $S$  = slope of the river bed

Nearby benchmarks should be available or be established to allow regular levelling of the gauge. Detailed selection criteria for water level gauging sites are presented in Chapter 2 of Part I of Volume 4, Field Manual on Hydrometry.

#### 4.5 SELECTION OF STREAMFLOW MEASUREMENT SITE

The majority of streamflow measurement techniques are based on the velocity area method. Even though the use of float measurements is sometimes inescapable, current meter gauging is the most widely favoured velocity-area method technique. For most situations the same general site selection criteria can be applied to each technique. The current Indian Standards on velocity-area method site selection (see Reference Manual) and current international practice (e.g. ISO 748) have been reviewed along with other considerations and a recommended set of guidelines have been prepared for

- for current meter gauging sites
- for float measurement
- for discharge monitoring by Acoustic Doppler Current Profiler (ADCP)
- for Slope-area Method
- for selection of Natural Control (rated section) station site, and
- for selection of Artificial Control Sites.

For a stage-discharge station, both a stage measurement device and a current meter gauging site are required in the same locality. However, **it might not always be appropriate to locate the current meter gauging site immediately adjacent to the stage measurement device since some of their site selection criteria are different.**

Detailed sets of guidelines for the distinguished measurement techniques are presented in Chapter 2 of Part I of Volume 4, Field Manual on Hydrometry, which should be carefully considered. Some important criteria are presented below.

---

### ***Current meter gauging site***

The selected site shall have a long, straight, uniform, well-defined approach channel upstream of the measuring section to ensure parallel and non-turbulent flow and to minimise irregular velocity distribution. In practice, the approach length is related to the channel width. Generally, for rivers less than 100 m wide a straight approach of 4 x channel width is considered to be sufficient, whereas for rivers greater than 100 m wide the current Indian minimum standard of 400 m straight approach should be adopted if possible. When the length of the straight channel is restricted it is recommended that the straight length upstream should be at least twice that downstream. The site shall be year round accessible and the section be stable, confined to one channel with no overbank flow. Sufficient flow depth should be available to provide effective immersion of the current meter and the flow velocities shall be within the calibration range of current meters ( $> 0.15$  m/s and  $< 3.5$  m/s). Above criteria also apply for other sites, with some additions.

### ***Float measurement sites***

Float measurements require a measuring track, which is straight and uniform in cross-section over a length of five times the average width of cross-sections. The riverbank shall be easily accessible to mark the passage of the floats and wind effects shall be minimum.

### ***Acoustic Doppler Current Profiler (ADCP) sites***

The ADCP is a device for measuring velocity, direction and cross-section. As such it is a velocity area device. However, in view of its technology it can cope with irregular velocity distributions and skew flow conditions. The choice of measuring cross-section is therefore not so critical as other velocity-area methods. The cross-section should, however, be free of rock or other objects to avoid damage to the face of the transducers. The equipment requires at least 1.5 m water depth below the transducers, which in turn are at least 0.3 m below the water surface. Hence, deep river sections are preferable. For safety reasons average velocities should not exceed 4 m/s, since the instrument will be boat mounted.

### ***Slope-area method discharge estimation site***

The site to which the slope-area method is applicable is straight and has uniform, stable cross-sections, with uniform hydraulic characteristics. Sufficient fall in the water table shall be available in the river reach to allow accurate determination of the water surface slope.

### ***Natural control (rated section) station site***

In practice there is very rarely an “ideal” location for a natural control (rated section) gauging station. It is often required to compromise and to establish stations in far from ideal conditions. The site selection is based on hydraulic criteria and on tactical considerations. The natural control should be selected where the relationship between stage and discharge is substantially **consistent and stable**, not affected by any significant backwater effect. The control shall be **sensitive**, such that a significant change in discharge, even for the lowest discharges, should be accompanied by a significant change in stage. Small errors in stage readings during calibration at a non-sensitive station can result in large errors in the discharges indicated by the stage-discharge relationship. Attention is to be given to land acquisition, security and staff availability.

***Artificial control sites***

There is a variety of different flow measurement structures. The choice of structure will depend on a number of factors including objectives, flow range, afflux, size and nature of the channel, channel slope and sediment load, operation and maintenance, passage of fish and not least, cost. The applications and limitations of a structure will determine where its use is most appropriate. In this regard each type of structure has its own specific site selection criteria. In addition to the above mentioned criteria artificial controls also require appropriate sub-soil conditions to provide a solid foundation for the structure. Since the structure will create some backwater effect, it may cause extra flooding.

## 5 MEASURING FREQUENCY

### 5.1 GENERAL

The frequency with which hydrological measurements are taken depends upon a number of factors, such as:

1. **The function which the data will serve.** More frequent observation is required for the assessment of peak flows especially for small catchments, than for some other purposes. Most hydrological measurements are made to serve multiple functions. The measurement frequency must meet the requirements of the uses planned for the data.
2. **The target accuracy of derived data.** It must be recognised that a policy of 'as good as possible' may lead on occasions to unnecessary expenditure on improving accuracy beyond what is needed for the purpose. i.e. there has to be a balance between the value of increased accuracy of data and the increased cost of providing that increased accuracy. There must at least be a notional upper limit on the size of the uncertainty band (accuracy) outside which the quality of the data would generally be unacceptable for its intended uses. Conversely, this uncertainty band should not be so small that the cost of providing data to such a high accuracy cannot be justified by the end result.

The accuracy of derived hydrological data will depend on the sampling density, the accuracy of measurement of the variable and the frequency of measurement. Sampling density determines the representativeness and spatial variability of the derived data and is mainly covered in network design (Chapter 3). The frequency of measurement as well as the accuracy of observation at a specific location will have an impact on the accuracy of the derived data determination for that point, e.g. mean daily flow, derived from a given number of stage values per day each of which is converted to flow, (see para. 4 below).

3. **The accuracy of observation.** Where observations are subject to random measurement errors, a larger number of observations are needed to meet a required target accuracy where the measurement error is large. The standard error of the mean relationship ( $S_{mr}$ ) in a stage discharge relationship is dependent both on the standard error ( $S_e$ ) of the observations and on the number of observations ( $N$ ), thus:

$$S_{mr} = \frac{S_e}{\sqrt{N}} \quad \text{where: } S_e = \sqrt{\frac{\sum d^2}{N-2}} \quad \text{and: } d = \left( \frac{Q_g - Q_r}{Q_r} \right) \times 100 \quad (5.1)$$

with:  $d$  = relative deviation of gauged flow  $Q_g$  from the fitted stage-discharge relationship  $Q_r$   
 $N$  = number of gaugings used to define the stage-discharge relation

4. **The time variability of the variable.** Fewer measurements are needed to determine the mean of a variable over given time, if the variable is uniform or changing very slowly than for a rapidly fluctuating variable. This is particularly important for the assessment of mean daily flow, a common basis for many hydrological studies. Small steep upland catchments respond rapidly to storm rainfall which itself fluctuates in intensity throughout a storm, giving a hydrograph, showing rapid rise and fall and sharply defined peaks. On flat lowland basins the hydrograph is smoothed by the variable timing of tributary inflows (though they may themselves be flashy) and by channel and reservoir storages. Smaller catchments thus need more frequent measurement in order to achieve the same accuracy of mean daily flow, than larger flat catchments and also for obtaining a sufficient number of points to define the hydrograph of an event. Many hydrological variables show a regular diurnal variation. This may either be natural as for climatic variables, arising from the periodicity of solar energy input, or, man-made, for example daily cyclic changes due the discharge of effluents or abstractions for irrigation. The frequency of measurements must be sufficient to define the mean over both the highs and lows of these periodicities. Reference is made to Chapter 4 of Volume 2, Design Manual, Sampling Principles, dealing with sampling at the Nyquist frequency and beyond.

5. **The seasonality of the variable.** Flows in rivers or streams are highly seasonal and during the monsoon the changes in stage and discharge can be rapid and large. Thus the frequency of measurement of stage has to reflect this. Therefore, during the monsoon season a higher measurement frequency is required (hourly or less). It can also be further reduced if an event is taking place i.e. more manual readings or event trigger set in data logger. The past manual practice in many States has been for daytime hourly observations of river level during the lean season and 24-hour readings during the monsoon. The latter requires two additional staff (and the associated increased costs) to ensure record continuity. Occasional out-of-season storms are missed by daytime reading only. Where variables are observed and recorded autographically (chart) and especially digitally, the required data for these out-of-season storms can be captured at negligible increased handling and processing cost (see next para.)
6. **The marginal cost/cost-benefit of improved accuracy.** If manual observations are undertaken, increasing the number of observations to improve the definition (accuracy) may require more observer time (man-days). Therefore, costs will increase proportionally and decisions have to be made on the benefits of the increased accuracy. However, where automated observations are already taking place either by chart or DWLR, the frequency of observation can be increased with only a negligible increase in cost.
7. **The benefits of standardisation.** It is simpler to process and analyse records which are arriving at the Data Processing Centre, all in the same format and with the same frequency of observation. This is true, both for manual data and for digital data, where batch processing of records by computer is simplified. It may be preferable for digital observations to standardise on a time interval close to the minimum requirement, than to adjust the frequency at each station to its functions, accuracies and time variability of the parameter being measured, many of which are imprecisely known.

In the subsequent sections the required sampling frequencies for stage and discharge are dealt with.

## 5.2 STAGE MEASUREMENT FREQUENCY

The procedure to determine the sampling frequency is outlined in Chapter 5 of Volume 2, Design Manual, Sampling Principles. For full reproduction of the stage variation a sampling interval slightly less than the Nyquist interval should be applied. This not only applies when interest is in peak flows, but when rates of rise and of fall of the hydrograph have to be reproduced to accurately determine the discharge of flashy floods in flat rivers. To estimate the mean flow over a certain period of time a larger interval will suffice. Below, the sampling frequencies suggested for various types of rivers and measurement techniques are presented. The frequencies given are indicative, based on past experience. **It is, however, necessary to verify the validity of these frequencies in view of the objectives.**

In larger flatter rivers of Peninsular India a general frequency of hourly readings of stage is usually acceptable. For a few small upland catchments used for special purposes or research, 15 or 30 minute observations may be used to define the rainfall-runoff response. For the design of minor irrigation schemes and bridge and culvert design on small catchments, 15 minute observations may also prove useful.

Different practice will be adopted depending on whether measurement is by staff gauge only, chart recorder or digital water level recorder, as summarised in Table 5.1.

For digital recorders the standard practice should be for a maximum time interval between readings of one hour. On large natural lowland rivers, such an interval may be unnecessarily small, but few such rivers in India are natural. Levels may change comparatively quickly as a result of river regulation and abstraction a short distance upstream. Information on such changes is often helpful in scheme operation and in analysis for example of times of travel. For small catchments, particularly those in mountainous, high intensity rainfall areas a frequency of 15 minutes may be required.

Observation by	Frequency	Remarks
DWLR	15 min/hourly	Dependent on size of catchment and purpose for which data is required.
AWLR	Hourly	Depends on scale of chart, more frequent readings (15 min.) could be extracted from daily and/or strip charts
Staff gauge only	Hourly 2 or 3 per day	Monsoon Lean season
Staff gauge with AWLR or DWLR	2 or 3 per day	
Stilling well inside reference level	Daily	

Table 5.1: Recommended observation frequency for stage measurements

For chart recorders, the record is of course continuous and information may be extracted at the interval required. The ease of extraction will depend on the scale and size of the chart. However, it is recommended that whenever possible a frequency of at least one hour is applied.

For manned stations with staff gauges only, hourly readings through a full 24 hr day (24/day) will apply during the monsoon, with the season defined according to the local climate. During the lean season, with the record already intermittent, hourly readings seem unjustified. Two or three readings per day will be sufficient, with the provision, that in the event of unseasonal rainfall and river rise, the observations are intensified and extended over the full 24 hours. In some circumstances one reading a day might suffice.

For stations where the staff gauge is supplementary to the DWLR or AWLR, the staff gauge will be read 3 times daily whilst the recorders are operating correctly but will otherwise revert to the practice noted above.

Where auxiliary/secondary gauges exist they will be read at the same time intervals as the reference gauge and the readings should be taken as close in time as possible.

For all stations level measurement should persist throughout the year, so long as there is flow and the **no-flow condition will be routinely observed and recorded daily**. The latter observations are very important; a nil flow is an observation, which must be recorded. Failure to do so results in confusion between 'no flow' and missing data.

### 5.3 CURRENT METER MEASUREMENT FREQUENCY

The required frequency of current meter measurement at a stage-discharge site depends primarily on the stability of the control section, as this will define how frequently gaugings are required to achieve a given level of accuracy. The minimum number of gaugings required establishing a good stage-discharge relationship for a stable, sensitive control is of the order of 10 -12 over the full flow range. The nature of rivers in Peninsular India is such that the controls are often insensitive and the uncertainties in current meter gauging are larger than desirable (> +/- 10%). Therefore considerably more gaugings might be required in order to define the stage-discharge relationship. A minimum number of 20 gaugings should at least be observed. The existing level of calibration is also important. A precise interval between gaugings cannot be specified as the need to gauge may depend on the occurrence of flow in a particular range.

Unstable channels and those affected by backwater or hysteresis resulting from unsteady flow will require more persistent and frequent measurement than stable controls.

Recommended frequencies are proposed and these are summarised in Table 5.2. However, these are only indicative and merely provided as a guide.



If more than one condition exists at a station then the condition requiring the most frequent gauging should be applied.

If a change in the control is detected at any station or if current meter gauging suggests that the rating has shifted, then gauging should be intensified until the new rating is defined throughout the range. At sites with very unstable controls it might be necessary to derive a new stage-discharge relationship for each season.

### **Mobile teams**

Stage-discharge sites with reliable, stable ratings, which only require periodic current meter gaugings, could be serviced by mobile field teams. Groups of sites should be selected within the same area/locality, which could be visited by mobile teams to undertake the current meter gaugings. Whenever feasible, the use of mobile teams should be encouraged, since it could reduce recurrent use and make more efficient use of limited, skilled manpower. In addition, this would minimise the amount of equipment required, since the teams could carry the current meters and accessories from site to site.

Before each monsoon season the Executive Engineer will draw up a schedule of stations within his jurisdiction outlining his recommendations where priority gauging is required, with ranges, where there is currently insufficient gaugings for accurate definition of the stage-discharge relationship. The schedule will be circulated to mobile and static teams for their action.

Station control	Frequency	Remarks
All stations (excluding structures) - initial calibration	Daily, more frequent gauging if appropriate to capture data for as wide a range of events as possible	> 20 each in low, medium and high flow range
Stable natural channel - well calibrated	Monthly plus at least one high flow event a year	The monthly gaugings can coincide with routine chart changing/DWLR downloading.
Backwater affected	Daily if backwater source not known Otherwise weekly	If an additional set of gauge posts are installed or an additional AWLR/DWLR, the changes in surface water slope can be estimated
Unstable channels with silt sand or gravel	Daily or more frequent to obtain data for high events	
Intermittently unstable channels with cobbles or boulders	Daily during monsoon Weekly during lean season	
Unsteady flow with looped rating	Weekly	Assumes that rate of change from stage records of stage can be well enough defined
Structures - Initially	6 gaugings over full modular measurement range to confirm calibration (performance) of structure, approx. 6 readings in the non-modular range.	Including 2 low flows. The modular limit should be defined
Structures - after initial calibration (performance) check	1 - 2 gaugings per year within modular range, 3 - 4 gaugings a year in non-modular range	

*Table 5.2: Recommended observation frequency for current meter gauging*

## 6 MEASURING TECHNIQUES

### 6.1 STAGE MEASUREMENT

#### 6.1.1 GENERAL

In Chapter 1 the **stage** or **gauge height** has been defined as the elevation of the free water surface of a stream relative to a local or national datum, measured by a gauge. Stage or gauge height is usually expressed in metres and hundredths (cm) or thousandths (mm) of a metre depending on the resolution required.

Records of stage may be of direct or indirect interest:

- direct interest: e.g. for flood or low flow levels, reservoir levels, etc., and
- indirect interest : to derive a second variable, e.g. the discharge of a river using a stage-discharge relation ( $Q = f_1(h)$ ) or the surface area and/or volume of a reservoir as determined by a stage-area and/or stage-storage relationship ( $A = f_2(h)$ ,  $V = f_3(h)$ ).

The determination of stage is therefore an important measurement in hydrometry. The reliability of continuous records of discharge derived from a stage record depends to a large extent on the quality of the stage record. Instruments and installations used to measure stage range vary from the very simple to highly sophisticated.

#### *Overview of water level gauges*

Water-level gauges in use in the HIS comprise:

1. **Non-recording gauges**, including:
  - Vertical staff gauges (Sub-section 6.1.2)
  - Inclined or ramp gauges (Sub-section 6.1.3)
  - Crest (maximum water level) stage gauges (Sub-section 6.1.4), and
  - Electric tape gauges (Sub-section 6.1.5)
2. **Recording gauges**, covering:
  - Float system with autographic recording (Sub-section 6.1.6),
  - Float system with digital recording (Sub-section 6.1.7), and
  - Pressure transducers (Sub-section 6.1.8).

#### **Note:**

1. The recording gauges are often distinguished according to the recording medium in Autographic Water Level Recorder, **AWLR**, and Digital Water Level Recorder, **DWLR**, which stores the data in an electronic data logger. The float system with autographic recording is then classified as an AWLR, whereas the float system with digital recording is called a DWLR as well as the pressure transducer.
2. A number of other non-recording and recording devices are in use in various countries, like wire-weight gauge, float tape gauge, chain gauge, hook and pointer gauges, bubbler pressure gauges and ultrasonic gauges. The reader is referred to Volume 4, Reference Manual on Hydrometry for further details and information on water level sensors used elsewhere.

In Sub-section 6.1.10 an overview is given of the various types of water-level gauges, preceded by an overview of available data loggers in Sub-section 6.1.9.

### 6.1.2 VERTICAL STAFF GAUGES

A staff gauge normally consists of a measuring plate fixed to a post set in concrete. The measuring plate is of enamelled steel or stable FRP with graduations of 0.01 m, see Figure 6.1. The staff gauge is bolted to a concrete or steel pole. The pole has slots to adjust the level of the plate. The staff gauge shall generally comply with IS 4080-1994. Alternatively, the staff gauge may be painted on a well-established and stable structure, like a bridge pier or retaining wall. At all hydrometric stations a staff gauge is required to measure the water level. The staff gauge is used:

- either as the sole means of obtaining the level,
- or as a reference gauge to set and check the water level recorder.

Where short interval data is required, e.g. small, responsive catchments the use of manually read staff gauges will be inadequate unless several observers are rotated (shift system) so that an observer is on site at all the time.

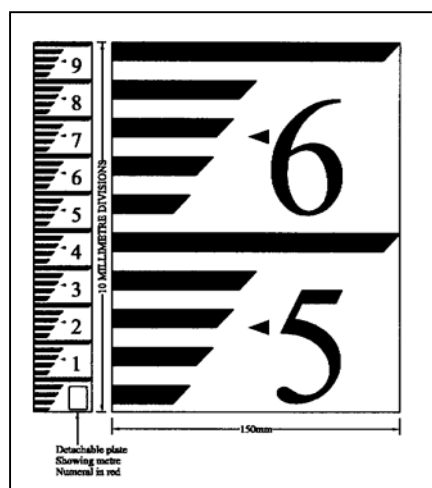

Figure 6.1:  
Close up of typical staff gauge

The following aspects of staff gauges are subsequently dealt with:

- Site requirements
- Station layout
- Installation aspects
- Operational aspects
- Maintenance
- Accuracy
- Staff requirements
- Auxiliary gauges
- Gauges attached to a stilling well
- Advantages and disadvantages

### **Site requirements**

The staff gauge should be located on stable banks, or attached to bridge piers or reservoir walls. At all times one should be able to read the water level from the gauge. Flow conditions should be such that little turbulence and wave action is experienced near the gauge posts to reduce measuring errors. Reference is made to Chapter 4 for detailed site selection guidelines.

### **Station layout**

A single set of gauges is normally employed at a gauging station. If apart from the stage also the fall is to be measured auxiliary gauges are required. When a stilling well is available to accommodate a recording gauge, staff gauges are placed inside and outside the stilling well.

To level the gauge, two permanent benchmarks of known level relative to mean sea level (msl) should be close to the site. If these are not available two independent sites within 500 m of the river should be available where station benchmarks can be installed relative to an arbitrary datum. This arbitrary datum should be related to msl as soon as it is practically possible. These sites should be whenever possible free from possible natural or human interference.

### **Installation aspects**

Vertical gauges are usually installed in sections of 2.0 metres length with a series of gauges stepped up the bank to a level exceeding the maximum flood level, see Figure 6.2. For stations where the water level is controlled by a weir, the zero of the gauges should coincide with the lowest weir level. For stations with a natural control, the zero must be lower than the lowest water level in perennial rivers and preferably at, or lower, than the lowest bed level in non-perennial rivers. The zero of all gauges should refer to mean sea level datum. The numerals must be distinct and placed so that the lower edge of the number is close to the graduation to which it refers. There must also be provision for the metre numeral on each metre length of plate.

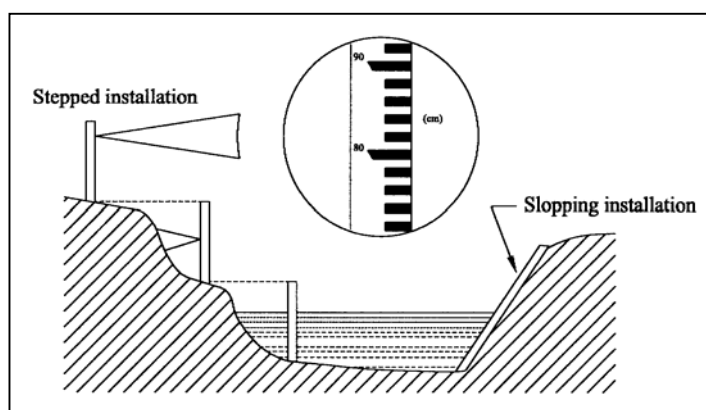

Figure 6.2a) & b): Vertical staff gauges stepped in series up a riverbank

Vertical staff gauges are fixed to reinforced concrete or angle iron supports, with cement concrete foundations extending to a level reasonably free from erosion or disturbance (usually about 0.75m). Angle iron supports are generally least vulnerable to damage by flood debris but in certain areas may be subject to theft.

---

### ***Operational aspects***

The staff gauges are manually read at fixed times each day (see Chapter 5). The reading times may vary seasonally. Where appropriate the gauges are also read during flow measurements.

The accurate recording of time is important, particularly during periods of rapidly varying stage. It is essential that all observers possess or have access to a reliable watch or clock.

Consideration must be given to the visibility of the gauges under all flow conditions, for example where access to the bank becomes difficult in flood conditions and the gauge becomes more distant. The simplest solution may be to provide the observer with a simple pair of binoculars. The averaging of stage readings during choppy but steady water conditions could improve the accuracy. However, this requires that a good, reliable observer is available.

### ***Maintenance***

Stability of staff gauges cannot be ensured and they are often exposed to movement or flood damage. Gauges must therefore be check surveyed with a minimum frequency of twice per year in the pre- and post-monsoon and on the occurrence of any observed disturbance or damage. The zero of the gauge plates and each individual gauge plate must be connected to a temporary or permanent benchmark and the circuit closed to the starting point with an error not greater than 5 mm. When a gauge is found disturbed, it should be reset immediately and survey information be recorded in the Field Record Book.

### ***Accuracy***

When the water level is gauged to estimate the discharge, the level should be accurate relative to a local datum. In such cases accuracy relative to national datum is not of importance. When flood levels are of concern then the accuracy relative local or national datum may be of concern.

The uncertainty in the water level reading is composed of:

- uncertainty in the zero of the gauge, and
- uncertainty in the gauge reading.

The uncertainty in the zero of the gauge depends on the accuracy of the levelling to the benchmark. The uncertainty in the gauge reading is a function of the accuracy of the graduations on the gauge plate, the hydraulic condition and the quality of the observer.

Under calm conditions, the staff gauge can be read to an accuracy of  $\pm 3$  mm. However, the reliability of observations is to a far greater extent dependent on the ability and reliability of the observer. This is an important consideration in the selection of station equipment and operation.

### ***Staff requirements***

When staff gauges are used for reference gauging one reading per day will do, so one observer will be sufficient. Stations, which operate with staff gauges only, are heavily demanding of manpower as three observers are required to ensure readings over the full 24 hours. This is a general requirement during monsoon periods when levels change rapidly. The gauge reader(s) shall be of type S-2 category.

### ***Auxiliary gauges***

At river sites two more sets of auxiliary gauges, set to the same datum, may be installed to determine the fall or water surface slope. The fall is of interest for the computation of discharge to be able:

- to correct for backwater effects,
- to estimate the hydraulic roughness for rating curve extrapolation, or
- to convert stage to discharge using the slope area method (see Section 6.6).

For the installation of auxiliary gauges there are two conflicting requirements:

- the distance between gauges should be sufficient to detect differences in water surface slope between the cross-sections,
- the time of measurement at the gauges be precisely synchronised if the stage is changing rapidly.

Generally, if one assumes that the uncertainty in level measurement at the upstream and downstream measurement gauges are the same, then the distance between the gauges should be sufficient for the fall to be not less than twenty times the uncertainty in the measurement at one gauge. Hence, if the uncertainty in the measurement at one gauge is 0.01 m then the gauges should be distanced such that the fall is at least  $20 \times 0.01 = 0.20$  m. Then, the uncertainty in the fall becomes:  $\sqrt{2} \times 0.01 = 0.014$  m (see Volume 2, Design Manual, Sampling Principles).

The greater the distance between the gauges, the greater the difficulty in ensuring time synchronisation. These difficulties must be considered when setting up and operating such stations; it may have consequences for the number of staff required.

### ***Gauges attached to a stilling well***

When a stilling well is used to accommodate a recording gauge, staff gauges are installed **inside** and **outside** the well, both having the same zero datum. The standard reference gauge must remain the outside gauge as the level on the inside gauge may be affected by blockage of the stilling well inlet pipe so that both staff gauge and recorder are registering the same inaccurate reading. In this case, comparison of inside and outside gauges provides a check on the functioning of the stilling well.

### ***Advantages and disadvantages***

Staff gauges are always required at hydrometric stations. To their advantage counts: staff gauges are simple, robust and easily understood. Disadvantages are that they do not produce a continuous record and that they are manually read.

#### **6.1.3 INCLINED STAFF OR RAMP GAUGES**

Inclined staff or ramp gauges are staff gauges designed to follow the natural slope of the riverbank, see Figure 6.3. Though in the field generally vertical gauges are applied, occasionally inclined gauges are applied provided that the riverbank is stable. Aspects dealt with for the vertical gauges are in general also applicable to inclined gauges.



Figure 6.3:  
Inclined staff gauge

The pro's and con's of inclined gauges relative to vertical staff gauges are as follows:

**Advantages:** inclined gauges are generally less prone to damage than vertical gauges, where rocky and stable banks exist. They also allow more accurate readings of the water level because of their better resolution.

**Disadvantages:** inclined gauges have to be individually prepared owing to the natural variation in slope angle. They should therefore only be used where flood damage to vertical gauges is expected. Also, they have found to be prone to movement and damage caused by bank collapse and slippage. As they are more complicated and time consuming to install and more costly to replace than vertical staff gauges, they are not currently in common usage in India.

#### 6.1.4 CREST STAGE GAUGES

Crest stage gauges, sometimes referred to as maximum water level gauges, are devices for obtaining the elevation of the peak flood level of a stream where continuous observation is not available. These are comparatively simple and inexpensive devices. The four most common methods are:

1. **Colour change gauges:** a water sensitive tape, which changes colour when in contact with water, is enclosed in a vertical tube. Water enters the tube at the base and washes off the colour up to the maximum height reached by the water, see Figure 6.4.
2. **Greasy pole:** the gauge typically consists of a vertical tube, containing a floating substance such as cork dust or saw-dust, which sticks to an inner greased pole.
3. **Non-returnable float gauges:** a float is raised, usually within a transparent tube and is held in place by a ratchet at its maximum level.
4. **Non-return valve gauge:** water enters the bottom of a clear plastic tube through a non-return valve and a column of water to the height of the maximum water reached, is trapped as the outside level recedes.

Examples of each of these are commercially available but can be readily constructed from simple materials.

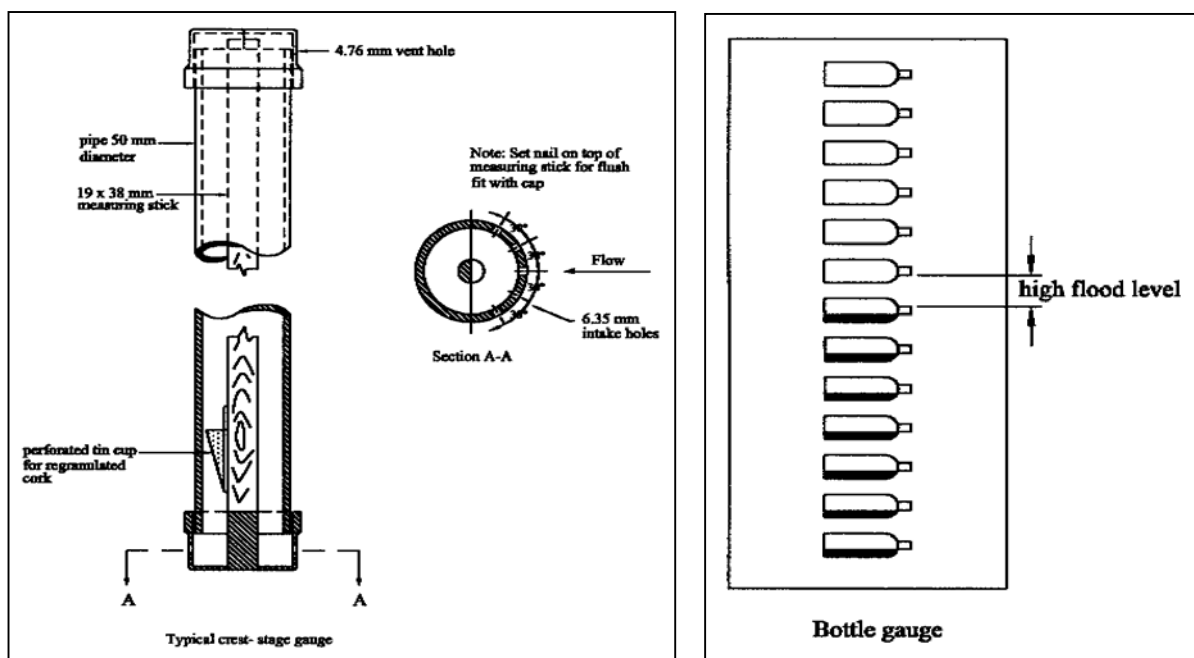

Figure 6.4: Maximum Flood Level (MFL) Gauge

The use of crest stage gauges upstream and downstream of the gauging site will provide important information on the slope of the water table during peak flow, which in turn is indispensable for proper extrapolation of the discharge rating curve. Its use is strongly recommended.

### 6.1.5 ELECTRIC TAPE GAUGES

The portable electric level indicator tape gauge consists of a graduated reel of steel or fibre reinforced plastic tape, see Figure 6.5. The tape and sensor are lowered until contact is made with the water surface, which completes an electrical circuit and sounds a buzzer. The gauge can be read to the nearest millimetre against a datum plate. The latter datum is at a known level above the zero of the gauge. The stage is obtained by subtracting the tape reading from the datum plate level. Power supply is through a battery.

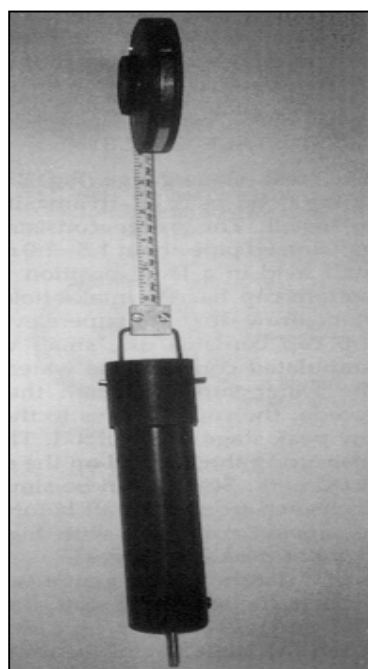

Figure 6.5: Electric tape gauge



Electric level indicator tapes are used where staff gauges are not easily installed or read, for example on the abutment wall of gauging weirs or inside narrow stilling wells, to provide an accurate level measurement alternative at such places.

### **Accuracy**

Specifications require that the electrical level indicator tape should have an accuracy equal or better than 2.5 mm/10 m at 20 °C. The temperature coefficient of the tape should be less than 0.0125 mm/°C/m.

## **6.1.6 FLOAT SYSTEM WITH AUTOGRAPHIC RECORDING**

### **Measuring principle**

A float sensor consists of a float attached to a beaded wire or perforated metal tape (on sprockets), at one end, and, to keep the wire/tape taut, a counterweight at the other end. The wire or tape hangs around a pulley wheel. The system is specially engineered to prevent slippage to assure that the stage fluctuations sensed by the float are fully transmitted to the pulley. The movement of the pulley wheel drives a chart recorder, see Figure 6.6.

A float sensor requires to be installed in a stilling well to protect the float and to damp out oscillations. The stilling well is connected to the river by means of one or more intake pipe(s) or perforations to ensure continuity between the river and stilling well levels, see Figure 6.7.

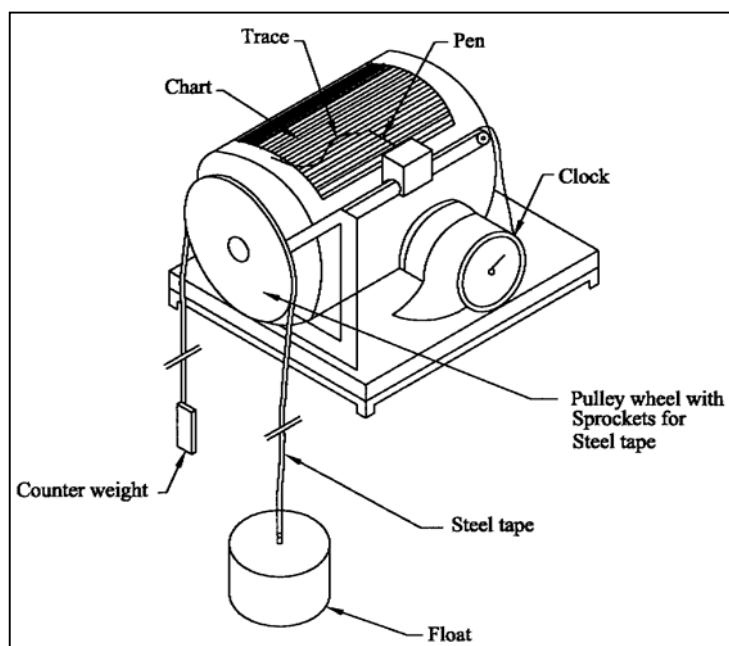

*Figure 6.6:  
Typical float, pulley and  
counterweight water level sensor*

Hence the float sensor system with autographic recording comprises the following components:

- A stilling well,
- A float sensor
- An autographic chart recorder, and
- Staff gauges inside and outside the stilling well.

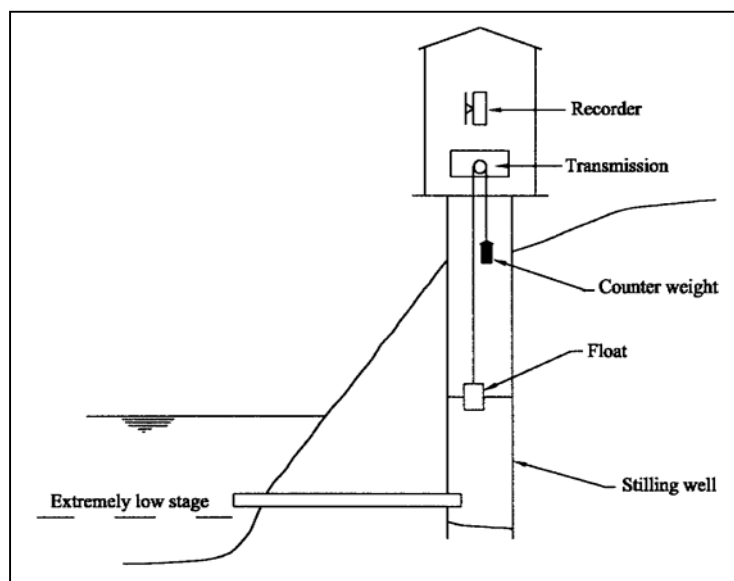

Figure 6.7:  
Float sensor in stilling well

These components are shortly dealt with below. Furthermore are discussed:

- operational aspects and problems,
- accuracy, and
- advantages and disadvantages

Full details one can find in Chapter 8 and in Volume 4, Reference Manual on Hydrometry.

### **Stilling well**

The stilling well accommodates the float sensor and needs careful design with respect to foundation or support, operational range, well diameter in relation to the diameter of the inlet pipes or perforations and de-silting arrangements.

A stilling well is either:

- a concrete tube or structure founded in the riverbank, with intake pipes, or
- a metal or plastic pipe attached to a bridge pier, a retaining wall or a ramp, with holes to connect the well with the river or reservoir

The latter solution is generally less costly than a structure on the riverbank.

The **height of the structure** is determined by the minimum water level one wants to record and the maximum flood level. The platform, carrying the pulley and recorder, should always be well above the maximum flood level to keep the equipment dry under all circumstances, whereas the distance between platform and the maximum stage is sufficient to allow the float to sense the highest stage. At the lower end there is generally more flexibility. The stage variation at the lower end is generally small and can well be taken from a staff gauge. By avoiding the lowest stages the intake of sediment is also reduced and it provides an easier means to clean the intake pipes when silted up.

The **inlet diameter** should be designed to balance the opposing influences of oscillation (small inlet required) and lag (larger inlet required). Leupold and Stevens suggest the inlet area to be  $1/1000^{\text{th}}$  of the area of the stilling well, i.e. an inlet pipe diameter, which is roughly  $1/30$  x well diameter if one pipe

is applied. The inlet area should also be designed to balance the ingress of sediment with the practical problems of its removal, whereas the diameter of the stilling well should be large enough to allow free movement of float and counterweight. The design of stilling wells is dealt with in Chapter 8.

**Static tubes** on the stream end of the intake pipes are often applied to reduce drawdown and superelevation effects caused by high velocities past the end of the pipe.

**Siltation** is the most serious problem in stilling wells. In rivers, which carry a heavy silt load, it is advisable to flush or clean wells after each flood. In other instances one or two flushings per year may be sufficient. There must be adequate equipment provision for stilling well maintenance. As a guide, one portable pump with accessories per 5 stations is usually sufficient for rivers with a heavy silt load. On other rivers one pump per 10 stations should be adequate.

### **Sensor**

Careful balancing of the float and counterweight is required over the operating range. The operating range is linked to the float/weight size and the wire tape weight. The accuracy obtainable depends on the float diameter. The larger the float diameter the higher the accuracy. Reputable manufacturers of this type of equipment will specify the combinations of sizes of float, counterweight and pulley arrangements for various level ranges and accuracies. These are to be used to achieve the desired performance. The pulley and recorder have to be installed on a fixed and stable platform or table, well above the maximum flood level.

For proper operation of the sensor in the stilling well it is of importance that:

- the water level in the well is the same as in the river,
- the well water level is error free transferred to the pulley.

For reasons of improper design and/or maintenance of the stilling well the water level in the well may deviate from the water level in the river. Similarly, the sensor may work unsatisfactory due to e.g. slippage of the wire, mechanical problems, etc. A full list of possible errors is presented below under operational problems.

### **Autographic chart recorder**

The autographic chart recorder, operating on a float and pulley based system provides a continuous trace of stage with respect to time on a chart. The movement of the pulley wheel is translated into a movement of a pen mechanism or the movement of the chart relative to a pen. A spring-wound mechanical or battery driven clock is part of the recorder. Data is extracted from the chart manually or by means of a digitising table or tablet. Two types of chart systems are available:

- a) drum type, where the chart is fitted to a vertical or horizontal drum. The following systems are in use:
  - the pulley drives the drum and the clock moves the pen, and
  - the pulley moves the pen and the clock drives the drum (see Figure 6.8)
- b) strip type, where a chart roll is clock driven from one spindle to another; the pen is moved by the pulley (see Figure 6.9).

Major difference between the drum and strip type recorders is that the latter can be left unattended for a longer period as the chart allows a longer record on a chart and/or can provide a better resolution. Drum type recorders require daily charts for flashy rivers to get sufficient resolution and weekly charts when the water level fluctuates slowly. Though the frequent replacement of the chart may look disadvantageous for the drum recorder, this is not necessarily so. The experience with the float

sensor in a well is that the functioning of the system should regularly be checked anyhow, irrespective of the type of chart recorder.

On both recorder types, changes in water level activate a pen or stylus on the stage axis of the chart. Recording scales range from 1:1 to 1:50. Most recorders can now record an unlimited range in stage by use of a pen-reversing device or by unlimited rotation of the drum. Gearing should be chosen with respect to the expected range in level at the station to give adequate definition for extraction without crowding the chart with too frequent reversals or drum rotations.

Errors in the recorded level due to the recorder can arise from malfunction or incorrect setting up of the recorder and/or chart, clock and mechanical problems, see below under operational problems.

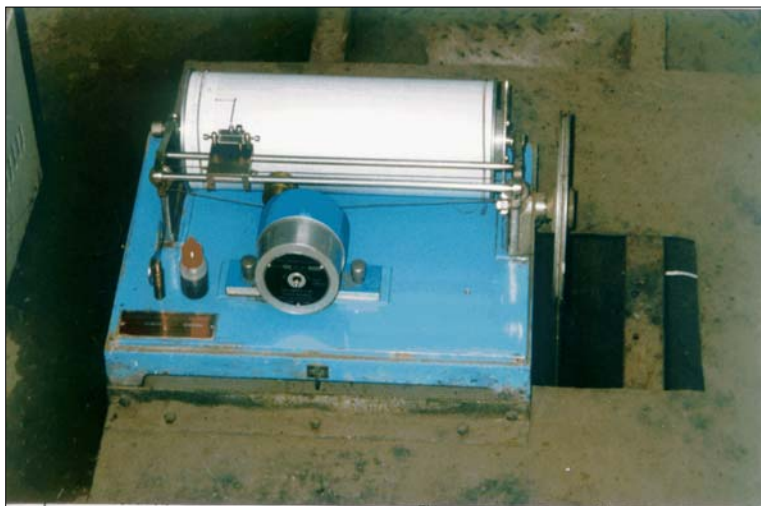

*Figure 6.8:  
Horizontal drum recorder*

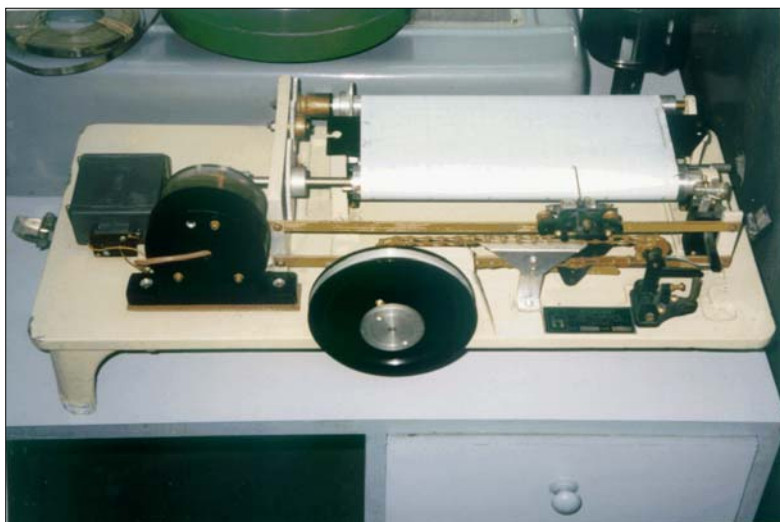

*Figure 6.9:  
Float operated strip chart recorder*

### ***Staff gauges attached to the stilling well***

Staff gauges are installed **inside** and **outside** the stilling well, both having the same zero datum. The standard reference gauge must remain the outside gauge as the level on the inside gauge may be affected by blockage of the stilling well inlet pipe such that both staff gauge and recorder are registering the same inaccurate reading. In this case, comparison of inside and outside gauges provides a check on the functioning of the stilling well.

---

### ***Operational aspects***

The float type sensor with chart recorder will provide an accurate continuous recording of the water level variation in the river if the design is correct and the system is well maintained. In view of a variety of operational problems, which may occur with the float sensor and its accommodation, it is required that the gauge is inspected daily. The clock of the recorder is to be checked as well as the recorded water level with the staff gauge inside and outside the stilling well. The gauge reader(s) shall be of type S-2 staff category.

### ***Operational problems***

Operational problems, that can arise with the float type sensor with chart recorder, are listed below. The problems with the sensor and housing and with the recorder are discussed separately.

The operational problems with the **sensor and housing** may be of the following kind:

- Sudden or rapid water level changes can cause wire slippage/tape sprocket jumps.
- Weight will catch onto the bottom of the instrument bench or floor of instrument house if the wire is too short.
- Weight submergence can cause errors since the tension in the pulley wire/tape will alter. It is not always possible to avoid this. However, whenever possible it should be avoided. Bottoming out of the counterweight on the base of the stilling well should definitely be avoided.
- Float lag may occur if the intake pipe or holes is/are too small a diameter or if it becomes blocked.
- Insufficient dampening of oscillations if the intake pipe diameter or size of intake holes is/are too large. Natural level oscillations and surges can result from rapid water level stages.
- Hysteresis effects may result from float, pulley and gear combinations.
- Mechanical inertia effects can arise with rapidly changing levels.
- Gear-train backlash effects can cause error due to gearing wear.
- Some float systems have additional guides and pulleys to redirect position of float or alter chart-recording scales, which can reduce sensitivity.
- Inadequate float diameter or badly matched float and counterweight.
- Tangling of float and counterweight wires.
- Float and counterweight reversed (pen driven in the reverse direction with respect to level).
- Kinks in float suspension wire or tape.
- Extension of the wire/tape due to temperature increases.
- Bridge and wall mounted stilling wells can vibrate at high flows.
- Build up of silt on the float pulley, affecting the fit of the float tape perforations in the sprockets.
- The stability of the mounting bracket or base is important. It is strongly recommended that the pulley and recorder are installed on a fixed and stable platform or table.

Operational problems with the **chart recorder** may be due to:

- Incorrect choice of gearing: the full range of water levels is not covered.
- Backlash in the gearing.
- Friction in the mechanism.
- Improper setting of the chart on the recorder drum or strip chart in the sprocket holes.
- Improper joining of the chart edges.
- Distortion and/or movement of the chart paper (humidity).
- Distortion or misalignment of the chart drum.
- Faulty operation of the pen.

- Clock inaccuracy, over-winding or failure to wind.
- Insects or other organisms in the mechanism or consuming the chart.

### **Accuracy**

A float operated recorder can be expected to sense the level to an accuracy of 3 to 5 mm, which may reduce to 10 mm for the accuracy of extraction of data from the chart, depending on the gearing and scale of the pen trace for recording ranges of the order of up to about 3 m. However, it must be realised that this can only be achieved with a high standard of maintenance and adequate checking, based on thorough training. As the recording range increases then the accuracy will further reduce.

The recorder shall generally comply with IS 9116-1979

### ***Advantages and disadvantages of float and chart type water level recorders***

**Advantages** - it is relatively simple to operate and maintain, is widely used, can provide an immediate direct reading of stage and provide a historic trace without requiring an external energy source.

**Disadvantages** - it is a mechanical device and therefore subject to errors from changes in temperature, hysteresis and friction. Also, the resolution of the chart scales, depending on the arrangement selected are sometimes a limitation on accuracy, the pen wears out and ink depletion occurs. Other problems can occur if the pulley wire becomes kinked, the counterweight becomes submerged or if the wires become displaced on the pulley wheel(s). Its operation therefore requires much attention. The chart has to be analysed or digitised to extract the data for entry onto a computer. This requires manpower and is a potential error source. Last but not least, the overall costs of the float sensor (initial and maintenance costs) are large, primarily due to the stilling well requirement.

## **6.1.7 FLOAT SYSTEM WITH DIGITAL RECORDING**

A float sensor consists of a float attached to a beaded wire or perforated metal tape (on sprockets), at one end, and, to keep the wire/tape taut, a counterweight at the other end. The wire or tape hangs around a pulley wheel. The system is specially engineered to prevent slippage to assure that the stage fluctuations sensed by the float are fully transmitted to the pulley. The movement of the pulley wheel drives a digital recorder. The float sensor requires to be installed in a stilling well to protect the float and to damp out oscillations. The stilling well is connected to the river by means of one or more intake pipe(s) or perforations to ensure continuity between the river and stilling well levels. Hence the float sensor system comprises the following components:

1. A stilling well,
2. The float sensor
3. A digital stage recorder, and
4. Staff gauges inside and outside the stilling well.

The components 1, 2 and 4 are exactly the same as for the float system with autographic recording. These components are discussed in the Sub-section 6.1.6. The only piece that differs is the stage recorder. Instead of recording the rotation of the pulley wheel on a chart it can directly be captured in digital format by a **shaft encoder**. Essentially a shaft encoder measures the angle of rotation, either **incremental** or **absolute**, see also Figure 6.10. The output from the shaft encoder is recorded on digital data loggers and can be shown on a LCD display.

The **absolute encoder** is able to signal exactly where its reference zero is located relative to the 360<sup>0</sup> field of rotation of its shaft, to a required level of resolution. The shaft-mounted disk is of glass (or similar light-transmitting material), patterned into "tracks" that, according to a binary pattern that alternatively obscures and transmits light from one side of the disk to the other. Absolute encoders of good quality and fine resolution are very expensive.

The **incremental encoder** signals the fact that shaft rotation is taking place as a train of logic pulses. Predominantly the incremental encoder is a revolution counter but which when linked to an appropriate counting mechanism can be readily converted into a rotational positioning device. Apart from cost the incremental encoder has the advantage over the absolute encoder that by its associated up/down counter it can track changing level multiple rotations of its shaft. This is particularly attractive for hydrometric applications where a high resolution is often required over a large level range.

The **Optical Incremental Shaft Encoder** is the type most widely used in hydrometric practice, though some specific proprietary data logging devices prefer to interface with **Optical Absolute Encoders**, for reasons of battery longevity. Examples of free-standing and parasitic shaft encoders are shown in Figure 6.11.

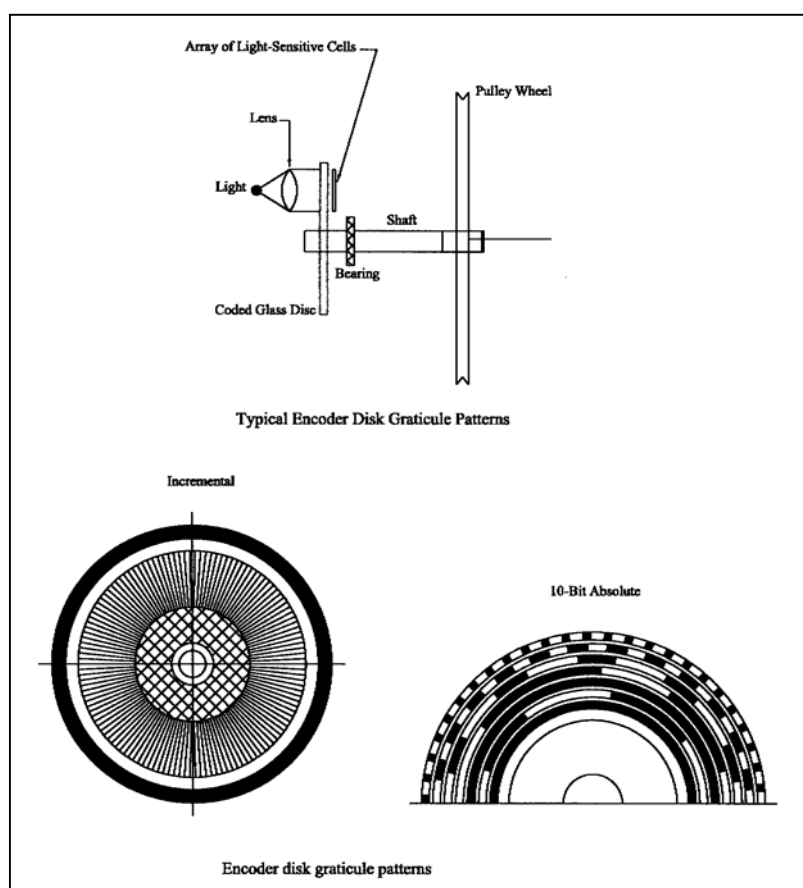

Figure 6.10: Basic features of the optical shaft encoder

#### Advantages and disadvantages of digital float-based water level recorders

**Advantages:** - they can provide as good an accuracy as the primary sensor i.e. the float system but do not have the errors associated with chart interpretation. For a well constructed float and pulley system they should be able to measure to  $\pm 3$  mm. Shaft encoders can be added to some normal float and drum type water level recorders and as such, a back up chart can also be used in case of logger failure.

**Disadvantages:** - because they are operated by means of a float system they require the construction of a stilling well. Also, they can be subject to errors similar to those experienced with conventional float and chart recorders such as problems caused by submergence of the counterweight and line, displacement of the wires on the float or counterweight pulleys and kinks in the float suspension cables. Reference level adjustment is required when setting up, i.e. the shaft encoder has to be set relative to staff gauge zero, which may be lost during operational use. Accidental fast rotations of the pulley wheel cannot be tracked.



Figure 6.11(a): free standing      Figure 6.11(b): parasitic

### 6.1.8 PRESSURE SENSORS (TRANSDUCERS)

The term pressure sensor is applied to devices, which convert changes in water pressure and hence water level into electrical signals, which can be recorded remotely from the point of measurement. A typical sensor consists of:

1. a mechanical force-summing device, perhaps a diaphragm or a bellows and resonating quartz crystal, which is displaced by the pressure head of water, and
2. a device which converts the mechanical displacement to an electrical signal.

The electrical signal is transmitted by a connecting cable to a solid state logger or to an associated interface for analogue to digital conversion before storage in the logger memory.

Gauging the water level by a pressure sensor does not require a stilling well, provided an electronic filter is applied to average out the pressure fluctuations due to turbulence. This makes the pressure transducer an attractive solution for water level gauging relative to a float sensor if no stilling well is yet available. An application is shown in Figure 6.12

The pressure transducer type DWLR consists of the following components:

- a pressure sensor
- a data logger with wave attenuation filter and power supply
- enclosure for pressure sensor and data logger:
  - either a submerged enclosure, where pressure sensor and data logger are integrated,
  - or an in-well enclosure, i.e. a submerged pressure sensor and a data logger above the water table
- a cable suspending the sensor
- a data retrieval system (Palmtop computer or Hand Held Terminal), and
- PC software.



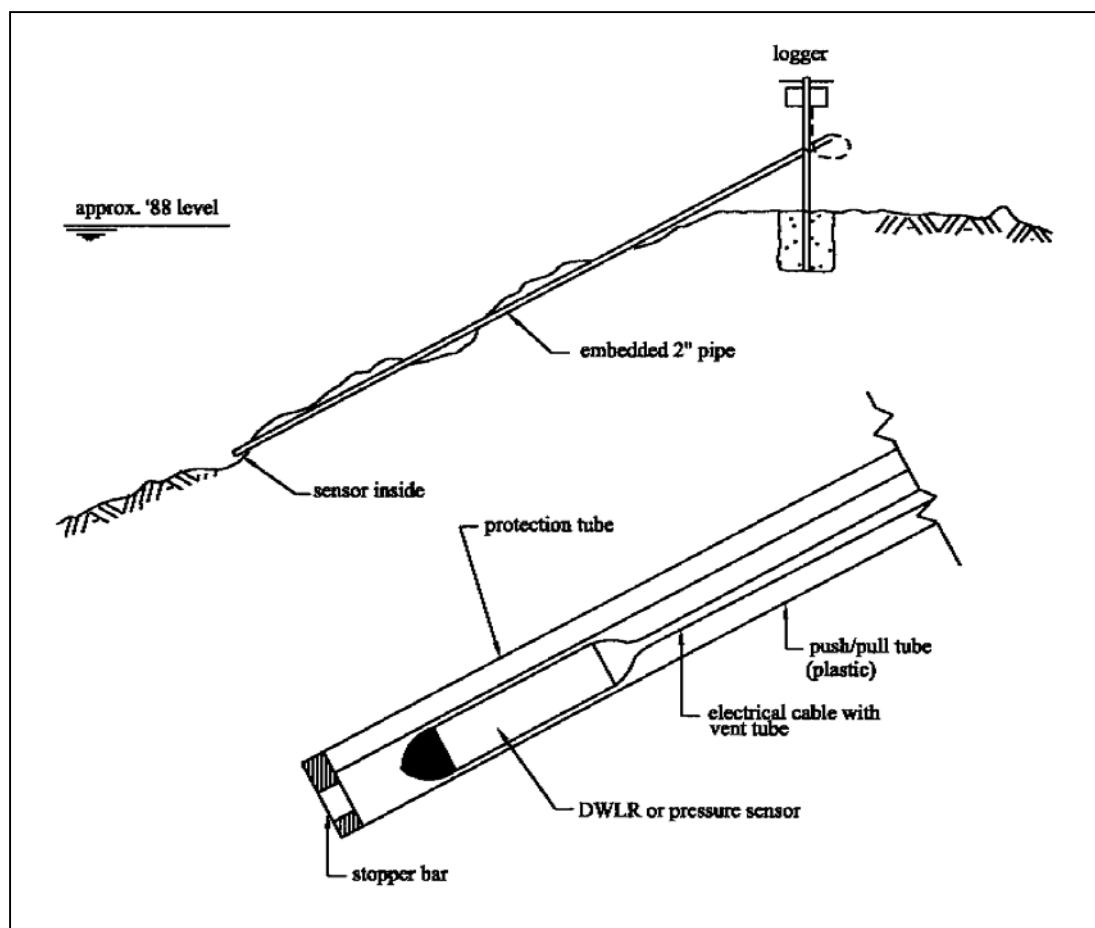

Figure 6.12: Water level gauging by pressure transducer

In this subchapter the following topics are discussed:

- principles of operation
- accuracy
- sensor selection criteria, and
- advantages and limitations

### ***Principles of operation***

The essence of a pressure transducer is that a sealed diaphragm is deployed at the interface between the instrument's interior and "the outside world", see Figure 6.13. This diaphragm is constructed so as to be sensitive to differences in pressure on one side relative to the other. Most present-day transducer designs make use of semi-conductors. In particular ceramic sensors are preferred which provide high stability, are not susceptible to fouling and are touchable. When there is a pressure differential, the diaphragm will distort (albeit minutely). The degree of this distortion will relate to the degree of pressure difference across the diaphragm, and should be relatively stable with respect to time and within achievable manufacturing tolerances. Some other device will be attached to the inner face of the diaphragm. This device will have the capability to translate the distorting movement of the diaphragm into a changing electrical characteristic. Appropriate electronic devices and circuitry may transform this, when suitably energised, into a varying electrical output, which may be processed for purposes of display or record. The processed data from the pressure sensor is normally stored on a data-logging device. Traditionally in hydrometric applications the logger has been remote from the pressure-sensing device, thus the need for the connection cable. However, some modern sensors have the logging unit housed in the same housing as the pressure sensor.

At any given time (usually at manufacture), the device may be precisely calibrated. A mathematical relationship may be established between the external pressure being applied to the device's diaphragm, relative to the internal pressure within the device's body, and a measurable electrical output.

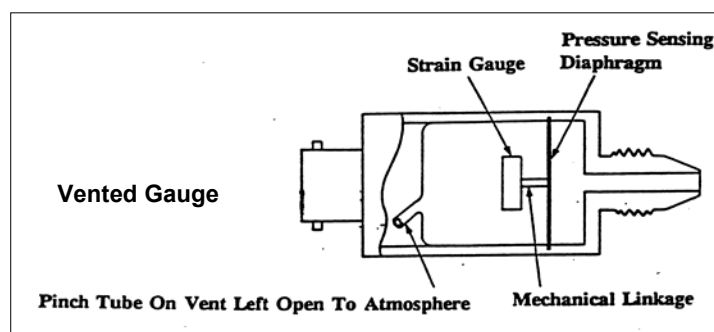
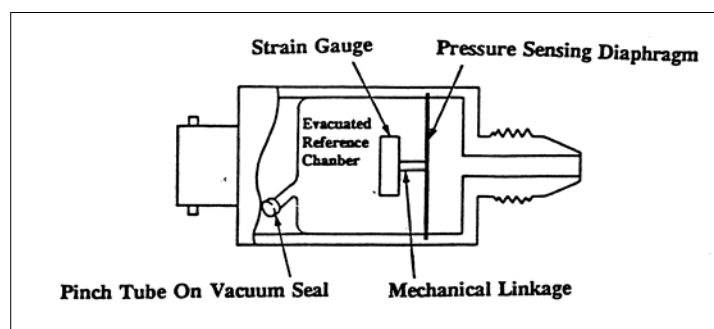
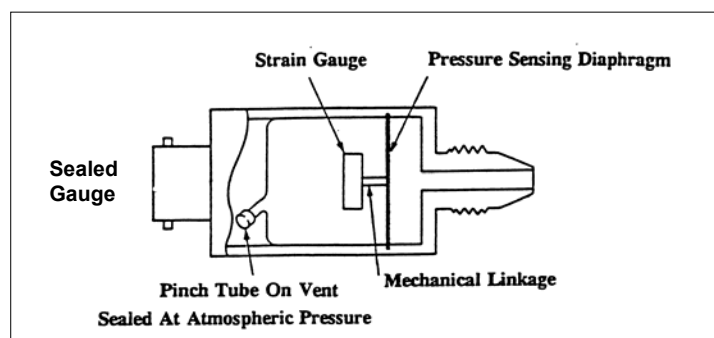

Figure 6.13:  
Schematic of Absolute, Vented and Sealed Gauge Types



In all transducers, water pressure and hence level is measured with respect to one of three references; this reference gives the transducer classification:

1. vented gauge – reference to atmospheric pressure;
2. sealed gauge – a fixed known pressure;
3. absolute gauge – vacuum.

Since all open channel flows are subject to atmospheric pressure, the vented gauge type is the most suitable for application to water level measurement. Ventilation is normally achieved by means of a flexible plastic tube that connects the interior of the transducer body with atmosphere, by way of the cable that also carries incoming electric power and outgoing signal conductors. The open end of this narrow gauge pipe is secured above water level and protected from condensation (e.g. using silica gel) and ingress of dust. However, blockage of the vent pipe through inadequate protection has been a recurrent problem with some sensors.

If an absolute pressure sensor is used it is necessary to adjust for atmospheric pressure. This normally requires the installation of another device above the maximum flood level in order to monitor changes in atmospheric pressure. One advantage of the absolute pressure sensor over the vented or gauge pressure type is the fact that if the logging device is installed within the pressure sensor housing there is no need to have a connecting cable carrying the vent tube to above the water surface.

The pressure sensor has the advantage of easy installation. Some protection of the cable on the bankside is essential and the transducer may be fixed in position in a perforated steel or PVC tube. However the installation cost is only a small fraction of the cost of construction of a stilling well and the equipment is only marginally more expensive than float based sensors. Additionally they will continue to operate when partly covered in sediment provided that the sensor's diaphragm is not touched by sediment. There is a power requirement for the transducer and interface in addition to the logger but typical dry cell battery life is at least several months.

Lightning strikes can be a source of danger to transducers and their associated instrumentation in particular long connection cables can 'pick-up energy'. Therefore, lightning protection is advisable taking the manufacturers advice as appropriate.

### ***Accuracy***

The accuracy of pressure transducers is usually expressed as a percentage of Full Range Output (FRO) or Full Scale Output (FSO) and is used to indicate that any given value of pressure (water level) sensed by the device may be expected to be accurate to within a stated percentage of the FRO value i.e. the calibration range of the device. Most of the better modern pressure transducers will have quoted accuracy's of 0.1% of FRO i.e. +/- 10 mm for a 10 m range transducer. This is acceptable for most hydrometric applications in India. Higher accuracy transducers are available but these are considerably more costly.

### ***Sensor selection***

There are a large number of manufacturers, and products vary widely in their accuracy, repeatability and robustness for river water level measurements. Also, manufacturer's specifications can sometimes appear complex and can be misleading. Therefore, before deciding on a type of sensor it is advantageous to have some basic understanding of the terminology and the technology i.e. how to interpret a specification? In this regard a Glossary of Terms and other Information is presented at the end of this sub-chapter. Below the main criteria are presented. However, any system procured must have a proven record of performance for river level measurement under the environmental conditions it will be used in, or should undergo prolonged, thorough and independent field testing before acceptance.

The following are the main criteria necessary in the choice of pressure sensor

1. **Pressure range.** A transducer is selected whose permitted maximum over-pressure rating is in excess of the greatest head likely to be encountered at the measurement site.
2. **Non-linearity.** The deviation of a calibration curve from a straight line.
3. **Hysteresis.** The deviation between an ascending and a descending calibration curve
4. **Span error.** The deviation from a predetermined output change measured between zero and full scale pressure
5. **Repeatability.** The difference between the outputs at identical pressures during successive pressure cycles

6. **Thermal zero and span shift.** The effects of zero shift due to temperature changes within the operating range.
7. **Long-term stability.** The errors of zero and span as a result of thermal cycling.
8. **Suitability for measurement in water.** Care should be taken in transducer selection; its housing assembly and cable sheathing should be suitable for immersion in water to pressures at least 50% greater than the maximum pressures being measured. Suitable anchorage points require to be provided for cables liable to flexure.

Beside the sensor, specifications for the data logger, enclosure for pressure sensor and data logger, cable, data retrieval system and software should be met, see Chapter 7. Special attention is to be given to ingress protection of the enclosure and cable assembly, and adequacy of the moisture blocking system to prevent condensation of water in the vent tube and in the sensor.

### ***Advantages and limitations of pressure sensors***

**Advantages:** - they give a direct reading of depth, do not require a stilling well to damp out water level oscillations and are thus relatively easy **and cheap** to install even though some form of protection is strongly advised. The cable does not have to be installed vertically and transducers are ideally suited for interfacing with data logging systems.

**Limitations:** - the levels of accuracy are typically limited to 0.1% of full scale, they are susceptible to changes in environment (manufacturer's stated accuracy is often at a constant reference temperature), they can be affected by changes in density of the water column, are some times susceptible to flow (velocity head) and electrical noise effects and are liable to drift over relatively short time scales (< 1 year).

### ***Glossary***

**Pressure sensors, transducers and transmitters.** For the purposes of this manual the term pressure sensor has tended to be used to describe a DWLR of the pressure sensor type. This is a general collective term, which is used to describe two types of sensors:

1. Pressure transducers;
2. Pressure transmitters.

There is a fundamental difference between the two, even though the term pressure transducer is often used to cover both types. The difference between the two types is as follows:

In a typical pressure sensor design an electrical potential is applied to one part of the circuit and an equivalent electrical potential sensed as an output from another part of the circuitry, the output being related to the degree of applied pressure at the transducer diaphragm. Conditioning/signal processing circuitry is necessary to accurately sense and discriminate the resulting output and convert it into a form for storage on a logger in digital format e.g. 4 - 20 mA or 1 - 5 V

For a pressure transducer the conditioning is undertaken remote from the sensor i.e. at the logger, whereas for the pressure transmitter this conditioning takes place at the sensor and the processed signal is transmitted back to the logger.

**Flash Powering.** Technique to power a sensor for only a few microseconds for a meaningful and repeatable measurement, while only draining the battery for a very small fraction to enlarge the life time of the latter.

---

**Linearity.** A sensor would be perfectly linear in its response to changing water level if a small change in water level, anywhere on the measuring range of the sensor, would result in the same change of the presented instrument reading. Linearity is defined in terms of two descriptors:

**FRO**, which stands for Full Range Output (sometimes FSO - Full Scale Output), and is used to indicate that any given value of pressure sensed by the device in question may be expected to be accurate to within a stated percentage of the FRO value e.g.  $\pm 0.1\%$ FRO (a typical value for a modern-day device).

**BSL**, which stands for Best Straight Line - a line midway between the two parallel straight lines closest together and enclosing all output vs. actual pressure (water level) values on a calibration curve.

Given indication of the two defining values referred to above, it may be known that a sensor will represent true pressure state, at any point within its intended operating range, and in terms of its inherent linearity characteristic, within + or - x% of the full scale value itself. An important, and sometimes operationally relevant, inference of this is that, in terms of absolute accuracy i.e. how accurate a sensed value may be, at any part of the transducer's operational range as a percentage of itself, low range values will be less accurately represented than high.

**Hysteresis.** The maximum difference in output, at any value within the specified range, when the value is approached first with increasing and then with decreasing value. This reflects the degree to which any two separate determinations of the same true value may differ if the previous states of true input have been respectively less than and greater than the present true input state. A low hysteresis value is clearly desirable, and is normally expressed as x% FRO (BSL) and often as a combined statistic with linearity.

**Temperature Effects.** Even though the effect may be small, may be well understood, and may be capable of electronic (or, even, software) compensation, to a lesser or greater extent all pressure sensors are sensitive to changing ambient temperatures. Typical expressions of this phenomenon include:

**Temperature Error Band**, i.e. the error band applicable over stated environmental temperature limits - normally expressed as "% FRO", and representing the additional error (i.e. on top of non-linearity, etc.) associated with changes of ambient temperature (at the sensor) outside the limits specified.

**Thermal Zero/Span Shift**, the Zero Shift due to changes of the ambient temperature from Room Temperature to the specified limits of the Operating Temperature Range - analogous to the Temperature Error Band, but applying solely to the accuracy with which true zero (or Full Scale) input is represented as output.

**Compensated Temperature Range**, the range of ambient temperatures within which there is in-built compensation to nullify the potential effects of changing temperature upon device output - usually expressed as an upper and a lower temperature value e.g.  $-20^{\circ}\text{C}$  to  $+30^{\circ}\text{C}$ .

**Zero Offset.** The within which the vented gauge pressure type DWLR reading may be expected to lie when in air. In other words, the reading may not deviate from zero by more than a specified margin, e.g. 0.02 m. The zero offset usually is compensated for during the instrument set-up procedure. The remaining error source then is the zero stability.

**Zero Stability.** Zero stability is expressed as the maximum change of zero offset that is permitted over a period of time, usually 1 year. In order to maintain rated accuracy, the zero change should be regularly checked.

**Ageing Effects (or Long Term Drift).** Over a sufficiently long period of time, any of the performance characteristics of a pressure sensor device may alter, due to the simple ageing process altering the physical state of its component parts - quite aside from the effects of general operational stress or of chemical processes (oxidation as a result of moisture ingress, for example, or corrosion through the ingress of gaseous chemicals). A pressure sensor is, inevitably, an assemblage of numerous separate components, made of almost as many different materials, each with its own characteristic reactions to thermal cycling. At every material interface, a greater or smaller degree of stress will be engendered whenever the materials' temperatures change and, accumulating, over many such cycles, physical changes take place that can affect the overall device calibration. The existence of the ageing process should be recognised through **periodic calibration checks** of all operational parameters detailed in the basic device specification - at intervals of time no longer than (say) three years, with less wide-ranging tests applied (in the field if necessary) at no greater than annual intervals.

In any organisation that uses pressure sensors as an everyday hydrometric tool on which reliance is to be placed, a high quality, portable **Pressure Tester** will be likely to be an essential support device. This device, in turn, should be subject to rigorous quality assurance procedures that allow its performance to be traced back confidently to an accepted Standard.

**Vulnerability to Atmospheric Electro-Magnetic Effects.** Pressure sensors are not only delicate in their mechanical construction (at least at the pressure sensing diaphragm), they can be sensitive also electrically. They are essentially (in the main) low-voltage, low-current devices. Also, the essence of their installation places, more often than not, their sensing element at some significant distance from other associated electronics, joined by (perhaps) many metres of power and signal cable - potentially a very effective antenna.

**Ambient Electric "Noise"** is present everywhere and, without appropriate precautions, can easily be picked up by instrumentation cabling to a degree that swamps the signal characteristic of interest. To protect against this, transducer cabling is invariably of the screened variety, and normally works effectively to exclude unwanted electrical noise. However, care is needed at installation time to ensure that the total integrity of cable screening is preserved. Joining lengths of cable is best avoided and, if unavoidable, requires the utmost care.

In joining transducer cable lengths, great care is also required to preserve the integrity of the ventilation tube. Similarly, in routing cabling between transducer and instrumentation, care is required to ensure that the ventilation tube is not blocked by being kinked.

**Lightning** can also be a source of danger to transducers and their associated instrumentation (indeed it is a hazard to most electronic devices deployed outdoors, or in the near-outdoors). In the case of submerged pressure transducers, a very effective path to earth may be provided for the high static voltages generated by atmospheric electricity as lightning. Where possible, electronic protection against high transient voltages should be incorporated in the installation design of all such devices - taking manufacturers' advice as appropriate. Almost inevitably, however, there will be instrumentation losses from time to time to lightning activity - relative incidence being, often, quite location-specific, with some sites much more vulnerable than others. Spares-holding policies should take this into account.

**Overall Device Sensitivity.** Sensitivity is the smallest change in the measured value that will result in a measurable change in transducer output. This parameter is a joint function of the mechanical sensitivity of the pressure diaphragm itself, and of the supporting electronic circuitry. It is not always indicated in a product specification, but may reasonably be assumed to be no worse than the smallest value of any of the stated parameters that define product performance in general. It is unlikely to be better than such a specified value.

A given degree of sensitivity required in the sensing of the water level is likely to be best achieved through careful selection of transducer range. If there is a conflict in the overall operational specification between range and sensitivity (or **Record Resolution**), it may be possible to reconcile the difficulty through use of two or more transducers, deployed to cover different parts of the Required Range overall.

If recourse is had to such a multi-transducer operational strategy, care will also need to be taken to consider the **Over-Ranging Capability** of one or more of the deployed transducers i.e. its ability to withstand, without damage to its performance, pressures significantly in excess of its nominal range. Note that a "Four-Times-Range" over-pressure provision is likely to be readily achievable by many commonly available proprietary transducers.

Note also that, in some applications, undue sensitivity in the transducer to changing input may be an operational disadvantage (e.g. response to wave action). Therefore, the sensor needs to be selected accordingly.

**Electronic/Software Wave Filter.** Conventional float and counterweight water level recorders require stilling wells in order to dampen out oscillations caused by wave action. Pressure transducers when used in rivers and reservoirs are also subject to wave action and some form of filtering or damping is required. This can be undertaken either electronically or in the logger software.

### 6.1.9 DATA LOGGERS

The float operated shaft encoder and pressure transducers referred to in Sections 6.1.7 and 6.1.8 above are ideally suited for modern data logging systems. Data loggers can be run off batteries and can store large quantities of date, time and level data. General specifications for such logging systems are contained in the Equipment Specifications, see Chapter 7. Essentially a data logger's functions comprise of:

- storing site and sensor identification data (configuration)
- control sensor power
- receipt of sensor signals
- conditioning of the signal to compatibility with the analogue to digital converter
- digitise sensor signal
- recording of data in solid state memory with associated time information.

In this subchapter types of logging systems are discussed and guidelines are given for making choices among the available data logging and retrieval systems.

#### *Types of logging systems*

There are 3 main types of data loggers commonly used for hydrometric applications:

- Loggers with separate removable memory
- Logger with integral memory retrieved by a portable computer (laptop or palm top PC)
- Loggers with integral memory, data captured by proprietary retriever/hand held terminal

Some loggers combine 2 or more of the above types. The loggers are discussed below.

### ***Loggers with separate removable memory.***

This type includes memory modules which plug-in to the data logger and are easily removed and exchanged with no special skills required for data collection in the field. The modules plug into a reader device attached to a PC computer with special software used to extract the data. Modern systems are based on industry standard PC Cards (PCMCIA). The PC - cards require the same care in handling as diskettes.

**Advantages:** card can easily be removed from the data logger and be replaced by an empty card by an unskilled operator, no computer required to collect the data, data can be sent by post.

**Limitations:** memory-logger link can fail, no way of field checking logger or validating or graphing data on most models, small memory modules e.g. PCMCIA can be easily lost or damaged. No back-up, hence data are lost if memory module is lost before transfer to PC.

Examples of this type of logger is presented in Figure 6.14.

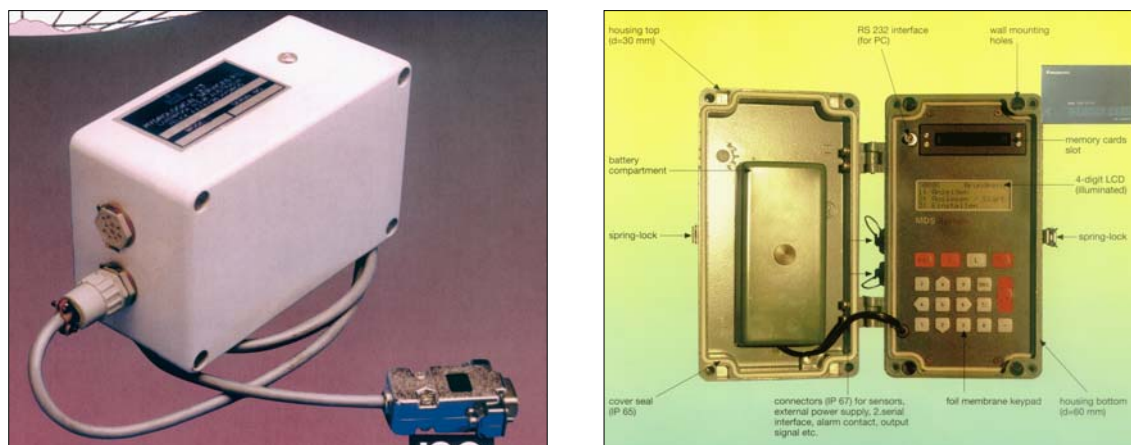

Figure 6.14: Data logger with removable PCMCIA card memory

### ***Logger with integral memory retrieved by a portable computer.***

Standard PC portables/ palmtops can be used with special software to control/set-up this type of logger, see Figure 6.15 and capture the data stored within. The same computer can be used for a range of different loggers just by running a different software package; the computer can also be used for other purposes. Traditionally the transfer of data has required a connecting cable between the logger and the PC. However, many of the latest generation of portable PCs now have an infrared data transfer facility. This type of technology is referred to as **Infra Red Datacommunication Adaptor (IrDA)**. The IrDA technology means that data transfer can take place by placing the PC next to the logger but without the need to make a cable connection. Only one well-known manufacturer of hydrometric equipment is using this technology at but it is anticipated that it will be used increasingly for data capture in future.

**Advantages:** data go directly onto a PC; for standard PCs a back up floppy disk file can be made immediately; software is readily upgraded; most software allows initial data validation/visualisation on site; PC based systems operate on any industry standard unit; retrievers can be used for other applications; spare parts for computers readily available; rugged waterproof PCs are available



**Limitations:** computer literate operator usually required to operate most systems; non-rugged PCs easily damaged and data can be lost; displays can often be poor in the field and difficult to read; rugged PCs are expensive operational autonomy on a single battery charge is usually limited to several hours maximum. The Windows hand-held PCs have a better autonomy.

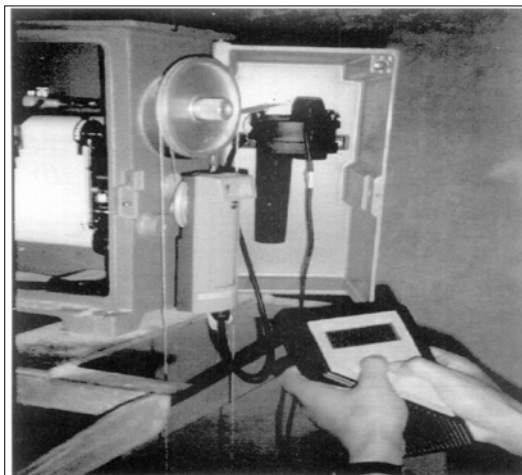

*Figure 6.15:  
Example of logger with integral memory, data retrieved  
by hand held computer*

Data retrieval computers may be of the following types:

**PC compatible lap top or palm top computers** with MS DOS or Windows CE operating systems:-

**Advantages:** Often least expensive, multi-purpose solution, readily maintained and repaired, graphics screen, little training required for computer literate personnel, light weight relatively robust. Support of IrDA for data communication. Can cater multiple brands of DWLR.

**Limitations:** not water proofed, poor quality of display in bright sunlight, new versions of operating system quickly replace older versions, palmtop PC models become obsolete rapidly, communication connectors are fragile.

**Other hand-held (palm top) computer computers using non-PC standard operating systems,** which are optimised for use in the field on small computers e.g. Psion Organiser:

**Advantages:** Inexpensive capital purchase, long battery life on standard, readily maintained and repaired.

**Disadvantages:** fragile, not waterproof, small keyboard, small screens (typically only 2 x 24 characters), no graphics on screen on many models, limited memory for data and programs, dedicated to few applications, software will not run on other computers, special training required.

**Robust, purpose designed, field PCs**

**Advantages:** can be used in harsh environments, waterproofed and shock proofed, data is more secure, screen designed for field use, longer battery life than standard laptop.

**Disadvantages:** keyboard is often smaller than lap top and less easy to use, limited internal and disk memory capacity with some models, non-standard operating systems with some models, relatively high capital costs, spares less readily available.

Figure 6.16 shows an example of accessory equipment for retrieving data with optical interface and a Computer System.

Loggers with integral memory, data captured by proprietary retriever/hand held terminal.

Many of the earlier types of data logger used in hydrometry were of this type mainly because low cost industry standard, portable, programmable computers were not available at the time of development. The method of operation is to connect the retriever to the data logger using a data cable and read the data held in memory on the system. Retrievers generally store recordings or logs from a number of different sites. The data retrieved is then downloaded onto a computer system with a special software package at the data processing base. The data retrievers are usually proprietary computers, travelling data loggers, or memory modules specially programmed for the purpose and totally dedicated to the application. It should be noted that retrievers cannot be used for application on other manufacturer's equipment.

**Advantages:** dedicated retrievers, less qualified operator required, often easier to make splash proof than standard laptop PC.

**Limitations:** data goes to retriever only - no back up can be made in the field, different terminal types usually required for different data loggers, retrievers can be expensive and less easily maintained; software is rarely upgradeable, the number of data loggers which can be downloaded before transferring data to the office PC can be limited, training required.

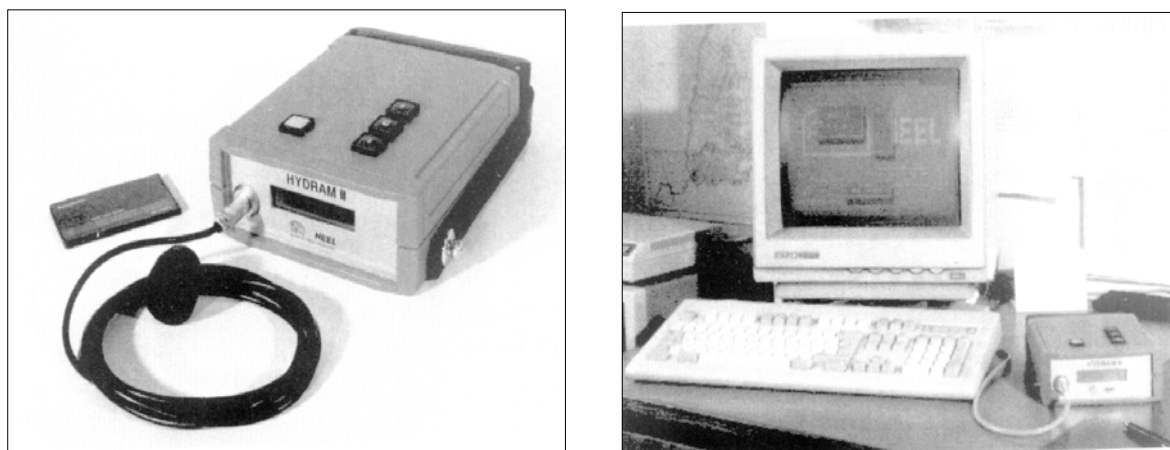

Figure 6.16: Example of accessory equipment and data being retrieved using Computer

### **Choice of data logging and retrieval systems**

The choice of which type or model of data logging and retrieval system to purchase will be dependent on a number of factors, including:

- Nature of the monitoring application
- The need for customisation of logging system for application (this should be avoided)
- Sensor compatibility with other sensors and loggers already in use
- Parameter(s) being recorded might restrict the choice of logging system
- Site and housing aspects, availability of environmental protection (NEMA/IP specs)
- Degree of data security required influences choice of logger and retriever
- Reliability of data capture influenced by quality of connectors/data cable
- Need for display and/or screen i.e. for checking current reading/time
- Remoteness of site and skills of observer - data transfer by post required?
- Life/autonomy of batteries will affect recurrent costs and data security
- Need for compatibility/integration with existing systems and software

- 
- Importance of maintaining/updating investment in hardware
  - Required robustness of field computer may restrict choice of logging system
  - The capital and/or recurrent costs of the logging/retrieval system
  - Sustainability in local setting and environment.

When choosing a data logging system, **the overall cost of ownership over the life of the system needs to be carefully considered**. The initial capital cost outlay needs to be balanced against the expected life of the product, the operating and maintenance costs, the risk of data loss plus any benefits such as convenience or time savings (manpower costs) provided during the operating life of the system. The capital cost of a system may be the lowest. However, it may be that higher operating, maintenance and other costs over a number of years push the overall cost of ownership higher than an alternative system, which has a greater capital cost of purchase.

It is important, that prior to investing in DWLRs and logging systems, that a clear, detailed specification of user requirements appropriate for India's conditions is prepared. Specifications for logging systems are included with those for digital water level recorders (see Chapter 7). However, as for the sensor itself, any data logging system procured must have a proven record of performance for river level measurement or should undergo prolonged, thorough, and independent field, testing before acceptance.

Compared with autographic recorders the advantages and limitations of data loggers are following:

**Advantages:** Directly computer compatible; once the data have been recorded it is relatively unaffected by environmental influence (charts can be affected by humidity); fast, efficient, less labour intensive; data can be recorded at some distance from the prime sensor because it can be transmitted without further degradation. No manual digitisation errors, no keyboard entry errors.

**Limitations:** - The process of converting from continuous signal to digital format invariably introduces an error. However, these errors are typically designed to be an order of magnitude less than those in the generation of the primary signal. The recording cannot be deciphered without specialist equipment. No loss of reliability and accuracy at data entry into the 'validation' PC.

#### **6.1.10 SELECTION OF STAGE AND WATER LEVEL SENSORS AND RECORDING EQUIPMENT**

The choice of the most appropriate water level sensor and retrieval system will depend on a variety of factors including but not limited to the following:

- Site conditions;
- Environmental capability;
- Corrosion resistance;
- Cost - both capital and recurrent;
- Frequency of measurements required;
- The required accuracy and resolution of the readings;
- The value of the information being acquired;
- The period over which monitoring is required;
- Ease of installation;
- Maintenance requirements;
- Compatibility with existing sensors;
- Power requirements;
- Proximity of high tension electric cables or similar - some systems might be effected by electrical noise;

- Calibration requirements;
- Ease of data handling;
- Back-up support.

Ultimately the final choice of any sensor and logging system meeting the technical specifications should be based on **cost of ownership**. Compatibility with the existing or proposed systems is also important and the installation of a single type of instrument at only one or two sites should be avoided unless special circumstances dictate otherwise. Some general specifications for different types of water level sensors are referred to in Chapter 7 of this manual. However, it is essential that prior to tendering users clearly define and specify their stage monitoring requirements. Also, they have to be in a position to interpret the various suppliers specifications on receipt of tenders. Provided the stage monitoring system purchased is a good one and the instrument is properly set-up and maintained there should be no significant problems in obtaining a good quality data return using the described techniques. As a word of caution some measurement techniques are rejected due to poor data return. This apparent poor return is often a fault with the particular instrument or the operator or both rather than the specific technique.

A comparison of the various water level sensing and logging techniques is summarised in Table 6.1 below. Note that in the table apart from those discussed in this chapter also the bubbler gauge and the ultrasonic in air (look down) water level sensor have been considered. The ultrasonic in air (look down) water level sensor has not been widely used in river conditions similar to those experienced in India but good operating experience has been obtained when it has been used in similar environments. All these methods of stage measurement have been widely and successfully used in similar conditions to those experienced in India.

Irrespective of what type of water level/stage measurement device is selected, there will always be a need for a staff gauge for reference purposes i.e. all other types of stage measuring devices have to be set up and checked against the reference staff gauge. As such the staff gauge is here to stay and will not be phased out by the introduction of new techniques.

## 6.2 INTRODUCTION TO VELOCITY AREA METHOD OF STREAMFLOW MEASUREMENT

### 6.2.1 BASIC PRINCIPLES

The volume of water passing a point in a river or other open channel (e.g. canal) in a unit time is referred to as the flow rate or discharge expressed in cubic metres per second ( $\text{m}^3/\text{s}$ ). Discharge is sometimes required as an instantaneous (spot) value but mean flow or an aggregated volume over a selected longer period of time (hourly, daily, monthly, annual) is more frequently needed. However, except in limited circumstances, discharge cannot be measured both directly and continuously. Normal practice is to make periodic measurements of discharge with concurrent measurements of stage. A relationship is then obtained between stage and discharge which permits the conversion of a continuous stage record into a discharge record.

Flow rate or discharge (Q) for a river cross-section can be determined from the mean velocity and area of flow:

$$Q = \bar{v} \times A \quad (6.1)$$

where:  $Q$  = discharge ( $\text{m}^3/\text{s}$ )  
 $\bar{v}$  = mean velocity in cross-section (m/s)  
 $A$  = cross-sectional area of flow ( $\text{m}^2$ )

This is known as the **velocity area method**. Most methods of discharge measurement are based directly or indirectly on this method.

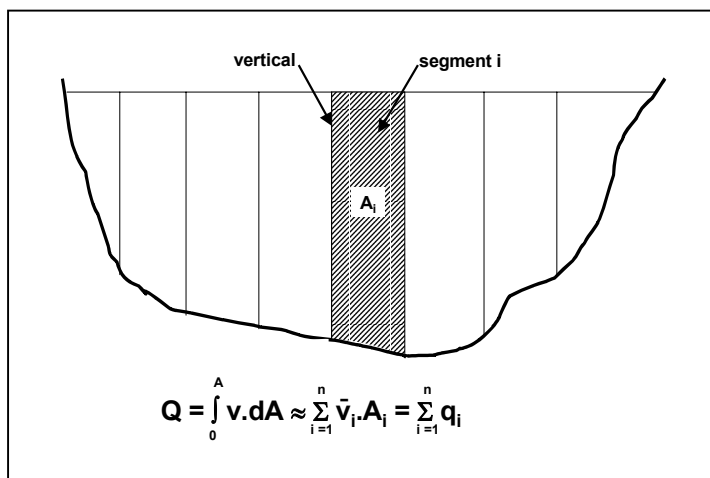

Figure 6.17:  
Sketch illustrating the velocity area method

Where velocity is measured by a point velocity technique (usually by current meter), velocity and depth measurements are made at a number of positions (verticals) across the channel cross-section, see Figure 6.17.

The portions encompassing each pair of these verticals are referred to as segments. The mean velocity ( $\bar{v}_i$ ) in each segment and the related segment area ( $A_i$ ) are determined and their product gives the discharge in each segment. The summation of the discharge ( $q_i$ ) in each segment gives the total discharge ( $Q$ ) in the measuring section (Area  $A$ ).

Thus:

$$Q = \int_0^A v \cdot dA \approx \sum_{i=1}^n \bar{v}_i \cdot A_i = \sum_{i=1}^n q_i \tag{6.2}$$

where:  $n$  = number of segments

Or simply:

TOTAL DISCHARGE ( $Q$ ) =  $q_1 + q_2 + q_3 + \dots + q_n$  = sum of discharge in each segment

The measurement of cross-sectional area is relatively straight forward in most rivers and other open channels. Depths can be measured at points across the cross-section using sounding rods or lines or echo sounders. The horizontal distance (width of cross section) or position in the cross-section can be determined by measuring tapes, calibrated cables or for larger rivers using sextants, electronic distance measurement devices (EDMs) or global positioning systems (GPS).

The **measurement of velocity** in the cross-section is less straightforward and for most techniques requires sampling of the velocity at discrete points or lines across the cross-section. Methods of measuring or estimating velocity in a measuring cross-section used in the HIS include the following:

1. Floats (see Section 6.3)
2. Rotating element (impeller) current meters (see Section 6.4)
3. Electro-magnetic current meters (see Section 6.5)
4. Acoustic Doppler Current Profiler (see Section 6.6)
5. Indirect methods using hydraulic formulae (Slope - Area) (see Section 6.7)

Other methods like: Time of Flight Ultrasonic flow meters, Acoustic Doppler flow meters and Electromagnetic river flow gauges used elsewhere are not considered appropriate for most Indian rivers and conditions at present and have therefore only been mentioned above for completeness. As such they have been given no further coverage in this manual.

## 6.2.2 FACTORS AFFECTING VELOCITY DISTRIBUTION IN OPEN CHANNELS

In order to make judgements on the selection of a velocity-area measurement site and the optimum velocity sampling density required, as a means of obtaining a good estimate of flow in a river cross-section, it is necessary to have an appreciation of the factors which can effect the velocity and depth of flow across the measuring section.

The velocity and depth of flow in an open channel varies both in time (temporal) and space (spatial).

**Temporal variations** are caused by the following factors:

1. Natural
  - The occurrence and variability of precipitation
  - The state of the river basin
  - Weed growth
  - Sedimentation
  - Wind - this can affect the surface velocity
  - Tides
  - Natural pulsations
2. Artificial
  - Opening and closing of river control sluices and gates and lock gates
  - Releases from reservoirs
  - Abstractions
  - Clearing of channels - dredging, weed removal
  - Movement of boats

**Spatial variations** of flow are caused by the following factors:

1. Natural
  - Channel size and shape
  - Channel gradient
  - Geology and vegetation - affects the roughness
  - Natural obstructions e.g. weed growth, fallen trees
2. Artificial
  - Channel modifications e.g. land drainage works
  - Dams, weirs and other structures (upstream and downstream effects)

Sensor Type	S W	Recorder	Accuracy	Maintenance	Staffing	Costs	Advantages	Disadvantages	Applications
Staff gauge	No	Manual - paper and pen	+/- 0.005 m	Simple	Low level	Low	Simple Robust Easily understood Always required	No continuous record Manually read	All
Float - Drum type	Yes	Chart	+/- 0.02m	Should be straightforward but seems to be a problem. Stilling well requires regular desilting	Relatively low level	Cost of recorder relatively low. High capital cost of stilling well  Also stilling well maintenance costs	Relatively simple and easy to understand; Widely used and available in India; On site record (chart trace); Should be relatively easy to maintain??	Cost of stilling well; Stilling well and intake prone to siltation; Resolution & accuracy limited by scale of chart (daily chart better than weekly) ; Data handling more time consuming than digital technology; Mechanical problems; Environmental - chart distortion (humidity)	Where continuous record required: rivers - bank or bridge, reservoirs with limited level fluctuation, flow measurement structures.
Float - Strip chart	Yes	Chart	+/- 0.01 m	More complicated than drum type	Relatively low level but some training required	More expensive than drum type. High capital cost of stilling well Also stilling well maintenance costs	Relatively simple and easy to understand but more complex than drum type; Can run for several months unattended if required; Widely used and available in India; On site record (chart trace); Should be relatively easy to maintain??	Cost of stilling well; Stilling well and intake prone to siltation; Resolution & accuracy limited by scale of chart but better than drum type; Data handling more time consuming than digital technology; Mechanical problems; Environmental - chart distortion (humidity)	Where continuous record required: rivers - bank or bridge, reservoirs with limited level fluctuation, flow measurement structures. Used in preference to drum type when better resolution & accuracy required and/or longer period between visits

Table 6.1: Comparison of different types of water level sensor

Table 6.1 (contd.) Comparison of different types of water level sensor

Sensor Type	S W	Recorder	Accuracy	Maintenance	Staffing	Costs	Advantages	Disadvantages	Applications
Float - Shaft encoder	Yes	Digital logger	+/- 0.003 m	Should be fairly straight forward. less replaceable parts to worry about than chart recorder e.g. no need for ink, charts etc.	Fairly high level - Some knowledge of modern technology including computers desirable	At present more expensive than chart recorder in India. However, in other parts of the world the costs are similar. High capital cost of stilling well plus stilling well maintenance costs.	Good accuracy & resolution; Ease of data handling; Can be fitted to existing, conventional chart recorders; Limited spares required.	Cost of stilling well; Stilling well and intake prone to siltation; Float and pulley problems e.g. tangling of wire.	Where continuous records required: rivers - bank or bridge, reservoirs with limited level fluctuation, flow measurement structures. Used in preference to charts if digital data required, and/or longer time between visits and/or better resolution & accuracy.
Bubbler	No	Chart or digital logger	+/- 0.01 m (chart) 0.005 m (digital)	Complex - gas cylinders require replacing	High level of knowledge of the equipment required	Relatively high equipment cost but no stilling well required. Relatively high cost of replacing gas cylinders.	Good accuracy possible; Works in high silt loads; No stilling well.	Replacement gas cylinders; Fairly complex requiring skilled maintenance; Can be effected by changes in water density.	Where stilling wells not feasible i.e. banks of rivers - with the advent of reliable pressure sensors it is believed that this type of sensor has limited application due to its inherent complexities
Pressure sensor	No	Digital logger	Range dependent - typically +/- 0.01 m for 10 m range	Relatively straight forward, if failure occurs it is normal to replace and return to manufacturer	Rel. high - computer knowledge desirable	At present more costly than chart recorders in India. However, based on experiences in other countries the costs could reduce significantly if use increases.	Direct reading of depth; No stilling well; Rel. easy & cheap to install; Cable does not have to be installed vertically; Ease of data handling.	Accuracy typically not better than 0.1% full range; Susceptible to changes in environment e.g. lightning protection recommended; Changes in water density can effect accuracy; Can be liable to drift over relatively short time spans (< 1 year)	Most hydrometric applications unless a very high accuracy (< +/- 0.01 m) is required. No stilling well required - can be fixed to river banks, bridge piers, retaining walls, reservoirs and boreholes.
Ultrasonic in air	No	Digital logger	Depends on level range. Say +/- 0.01 to +/- 0.05 m	Relatively straight forward, if failure occurs replace and return to manufacturer	Rel. high - computer knowledge desirable	Higher than chart recorder but costs could come down if there was a large demand.	Can be mounted above the water surface so relatively easy to install and maintain; Ease of data handling.	Acoustic beam has to be focused to avoid spurious deflections; Temperature gradients can cause inaccuracies; Absolute errors can increase with decreasing water level; Dead band effect.	At locations such as bridges or reservoir walls where it is not easy to fix transducers. However, the uncertainties will increase with increasing distance between the water surface and the sensor.

Key: SW - Stilling well required? Yes or No.



The mean velocity in a river or other open channel cross-section can be determined by the Manning formula  $\bar{v} = 1/n R^{2/3} S^{1/2}$  (see Chapter 2), which describes the velocity as a function of the Manning roughness coefficient  $n$ , the hydraulic radius  $R$  and the energy slope  $S$ . For natural streams  $n$  varies from 0.025 in straight smooth channels to about 0.15 to very weedy channels with deep pools and thick vegetation on the banks. In relatively uniform channels under steady flow conditions the energy slope is often assumed to be equal to the bed slope.

From the Manning equation it is observed that the velocity is a function of **the physical nature of the channel and its geometry (shape)**.

The velocity at any point in a river, even when the discharge is constant and, when the surface is apparently smooth and free from surges and eddies, is continually fluctuating with time. This **pulsation** is caused by secondary currents developed by hydraulic conditions upstream of the gauging site e.g. obstructions in the approach channel, surging caused by riffles or rapids being continued through pooled reaches, or by acceleration of the water at bends. Generally, the velocity at any point changes in cycles, varying in length from a few seconds to more than an hour. The extent of such pulsations has a bearing on the time selected for monitoring point velocity at each sampling position.

In natural rivers and other open channels velocity varies not only along its length but also in the vertical and horizontally across the channel cross-section. Where point sampling methods of velocity measurement are employed it is necessary to have an understanding of the variation of velocity across the cross-section in order that the mean velocity in the whole measuring section may be determined.

### 6.2.3 DISTRIBUTION OF VELOCITY

In most river situations maximum velocities tend to be found just below the water surface and away from the retarding friction properties of the banks. However, the distribution of velocity across the cross-section will be dependent on upstream and downstream channel conditions. In long, straight, smooth, uniform channels the velocity distribution will be fairly symmetrical about the centre line of the channel. However, severely skewed distributions can occur immediately downstream of sharp bends or partial obstructions, which can create the higher velocities on one side of the channel.

The velocity distribution across a river cross-section can be best examined by the plotting of lines of equal velocity determined from a large sample of point measurements. These lines which are similar to contour lines on maps are known as **isovels**. Typical isovels for various channel shapes are shown in Figure 6.18.

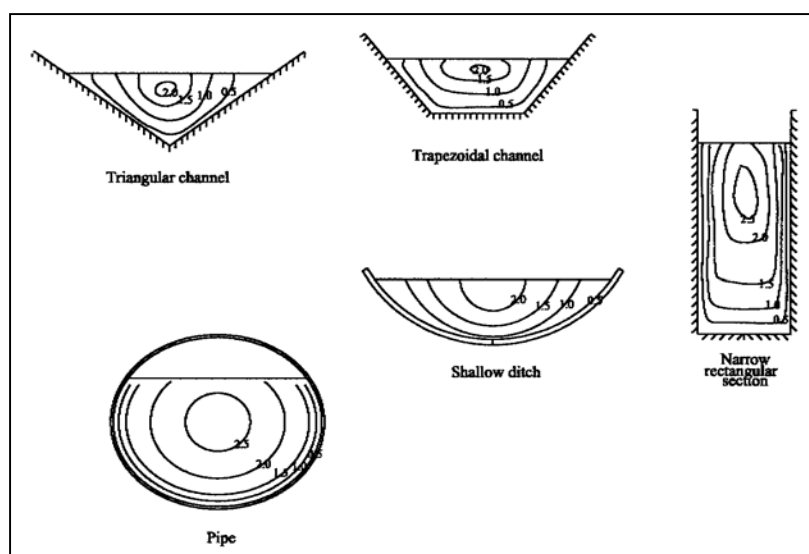

Figure 6.18:  
Typical curves of equal velocity  
(isovels) in various channel  
sections

(Source: Open Channel Hydraulics by  
Ven Te Chow, 1959)

It can be seen from these plots that velocity varies across the measuring section both in the horizontal and vertical direction. In most fairly straight rivers and open channels with fairly regular cross-sections the distribution of velocity in any vertical across the cross-section has a fairly standard form with a shape similar to that shown in Figure 6.19. In Chapter 2 it has been shown that the velocity profile in a wide river is well described by a logarithmic or power law profile.

The mean velocity occurs at approximately 0.4D from the bed or 0.6D from the surface. Hence, one way of estimating the average velocity in a vertical is by measuring the point flow velocity at **0.6D from the water surface**. Various other procedures exist to estimate the average velocity in a vertical from point observations, which will be dealt with Section 6.4.

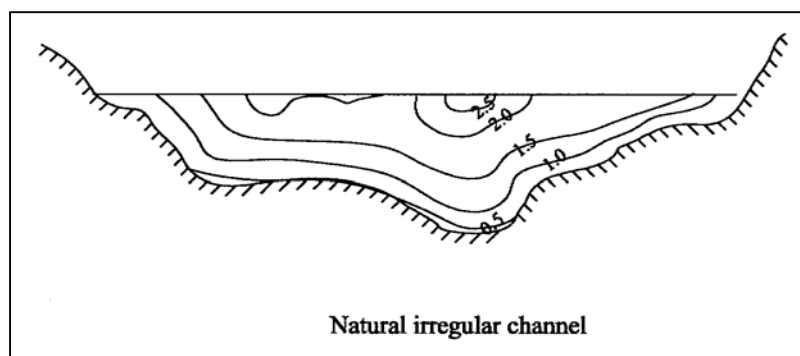

Figure 6.19:  
Velocity profile in a natural  
stream

### ***Departures from Normality in the Velocity Profile***

In most free flowing rivers with long straight, unobstructed approaches to the measuring cross-section the logarithmic/power form of the velocity distribution should apply i.e. the mean velocity should occur at approximately 0.6D. However, in many circumstances the hydrometrist is required to undertake measurements at far from ideal sites. At difficult sites irregular velocity profiles can occur. Factors, which can cause the velocity profile to deviate from its normal form, include:

- Aquatic weed growth
- Natural obstructions in the channel both upstream and downstream of the site, such as boulders, dead trees and shoals
- Artificial obstructions upstream and downstream of the site such as weirs, dams, bridges and culverts
- Unusual flow paths caused by skew flow and back flow
- Gate opening and closing at control weirs

## **6.3 FLOAT MEASUREMENT**

### **6.3.1 BACKGROUND**

Floats are the simplest and undoubtedly, the earliest form of flow measurement. Many flow measurements in India are undertaken using the float method since there is often no other viable alternative. However, their use is not recommended unless it is impossible to employ a current meter because of excessive velocities and/or depths, because of the presence of excessive amounts of material in suspension, in cases of reconnaissance or due to current meter failure. Nevertheless, floats still remain, a simple and cheap, albeit less accurate method of estimating the discharge in a river section. As such they still have a role to play in Indian hydrometry.

Velocity as determined by floats is neither a local velocity, nor an instantaneous one, since the mean value of the velocity ( $v$ ) in the time ( $t$ ) over a measured float path length ( $s$ ) is determined:

$$v = \frac{s}{t} \quad (6.3)$$

The technique involves the timing of floats over a measured length of as uniform a river reach as possible (preferably 3 - 5 times the width of the river). A minimum duration of measurement of 20 seconds is recommended. If possible the floats should be released at sufficient distance upstream of the measuring reach to allow them to attain constant velocity. Also, it is desirable to release the floats at different distances from the bank. Float measurement is described in detail in International Standard ISO 748, Measurement of liquid flow in open channels - Velocity-area methods.

The surface velocities obtained by float measurement have to be adjusted to obtain the mean velocity in the channel cross-section. The factor to apply is dependent on the depth of submergence and the shape of the float. Coefficients have been derived for different types of purpose built float. Normally, for surface floats i.e. floats which are not significantly submerged the coefficient used to estimate the mean velocity (in vertical over float path length) from the surface water velocity is of the order of 0.8 to 0.9.

In simple terms the flow is basically obtained by estimating the mean surface water velocity ( $v_{s,i}$ ) in each segment of the cross-section in the measuring reach, and multiplying this by the float coefficient ( $C_f$ ) and the mean cross sectional area ( $A_i$ ) of the segment in the reach to get the segment discharge ( $q_i$ ) and subsequently summing the segment flows.

In high floods and other difficult conditions it is sometimes possible to undertake float measurements but not measure the cross section. In such circumstances the level in the river should be ascertained relative to a fixed datum e.g. bridge parapet. The cross-section can then be measured at a later stage once it is possible to survey the channel.

### 6.3.2 TYPES OF FLOAT

There are three main types of purpose built floats, see Figure 6.20.

1. **Surface floats:** these are the simplest type of float. They are however, most readily influenced by wind. These typically have float coefficients of between 0.8 and 0.9 with a value of 0.85 being taken as a reasonable average. Many Indian practitioners currently use a coefficient of 0.89.

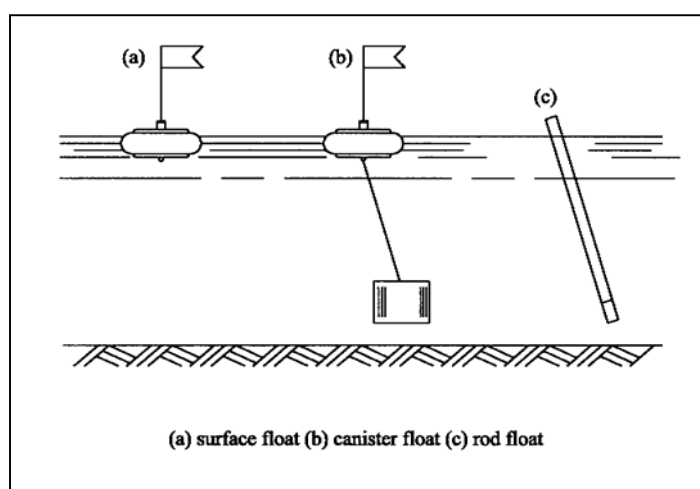

Figure 6.20:  
Types of float

(Source: Streamflow measurement by R. W. Herschy, 1995)

2. **Canister (double/sub-surface) floats:** these consist of a submerged canister or sub-surface float connected by a thin length of adjustable line. The canister dimension and its immersed depth are chosen so that the float velocity is equal to the mean velocity in the vertical. Normally therefore, the coefficient should be or close to 1.0.
3. **Rod floats:** these are cylindrical rods weighted so that they float vertically in still water with only their tip protruding above the surface. They are used to measure the mean velocity in the vertical and are designed so that they extend through as much of the stream depth as possible without the lower end ever touching the bed. The float coefficient will depend on the length of the rod relative to the depth of flow in the float's flow path. Typically values might be from 0.9 to 1.0.

Floats must be easily recognisable. Therefore the use of distinctive colours is recommended.

It is not necessary for floats to be purpose built. The following are often used to undertake float measurements:

- Floating debris including trees and other flood debris (it is particularly good if the majority of the object is submerged);
- Coconut shells;
- Weighted cans or lemonade bottles;
- Wood.

It should nearly always be possible to find a suitable float at any site. **An estimate of flow is usually better than no estimate at all.**

### 6.3.3 FLOAT MEASUREMENT TECHNIQUE

The selection of a float measurement site is described in Chapter 4 and a proposed observation methodology and observation practice considered to be appropriate for Indian conditions is contained in Volume 4, Field Manual, Hydrometry. However, the following general practice is generally applied but where necessary adapted and changed to suit local conditions.

Three cross-sections are required along the reach of the channel at the beginning, mid-point and end of the measuring reach (length). The cross-sections shall be far enough apart for the time taken for the floats to pass from the beginning to the end of the reach to be measured accurately. The midway cross-sections are used only for the purposes of checking the velocity measurements between the cross-sections at the beginning and at the end of the reach. A minimum duration of float movement of 20 sec. is recommended. The following are the general steps in a float measurement procedure:

1. The floats shall be released far enough upstream from the first cross-section in order to obtain a constant velocity before reaching the first cross-section.
2. Whenever possible the floats should be released from a bridge or from a boat so that they can be released at set intervals across the channel.
3. The time at which the float passes each cross-section is noted. This means that observers should be stationed at each cross-section so that they can signal to the time keeper(s) when the floats are in line with each section.
4. The distances of the float from the reference bank as it passes each cross-section may be determined by a suitable optical means, for example using a theodolite, sextant or range finder (low accuracy).
5. The above procedure should be repeated with floats at different distances from the reference bank of the river.

6. The channel cross-section should be divided into a certain number of segments of equal width. If, however, the channel is very irregular each segment shall have approximately the same discharge. The number of segments should preferably be a minimum of five and never less than three.

### Positioning of floats

As an alternative to using a theodolite or other specialist surveying equipment, the double stopwatch method can be used. This is described as follows and illustrated by Figure 6.21.

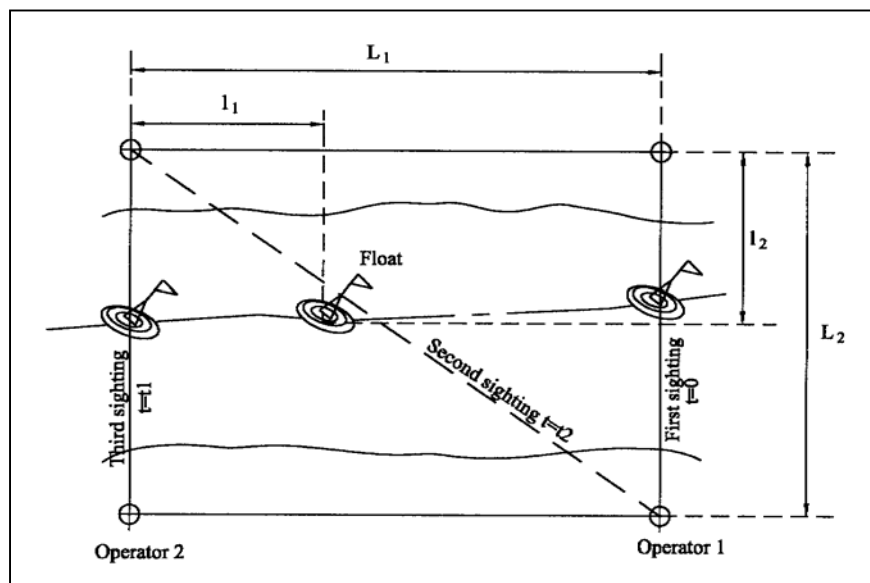

Figure 6.21:  
Sketch to illustrate float  
positioning using the  
double stopwatch method

(Source: Streamflow  
measurement by R. W.  
Herschy, 1995)

Two stopwatches are used. Two parallel base lines are established on each bank. The start and end of these baselines correspond with the beginning and end of the float measurement reach and are marked by suitably, visible beacons or ranging poles. One observer stations himself at the upstream end of the reach and the other at the downstream end. Both observers start their stopwatches at a signal from observer 1 when the float passes the upstream section. Observer 1 stops his stop watch when the float crosses the diagonal between his reference position and the beacon on the downstream opposite bank (time  $t_2$ ) the second observer stops his watch when the float passes the downstream cross-section (time  $t_1$ ) If the upstream and downstream cross-sections are parallel and the length of the baselines are  $L_1$  and the distance between the beacons on each bank is  $L_2$ , then from figure 6.21, using similar triangles:

$$l_1/L_1 = l_2/L_2$$

Therefore:  $l_1 = L_1 \times l_2/L_2$  (6.4)

Assuming uniform velocity, the ratio of the sides of the similar triangles will be equal to the ratio of the times ( $t_1 - t_2$ ) and  $t_1$ , thus:

$$l_2/L_2 = (t_1 - t_2)/t_1$$

Therefore:  $l_2 = L_2 \times (t_1 - t_2)/t_1$  (6.5)

Good communication and understanding is required between the upstream and downstream observers.

### 6.3.4 DETERMINATION OF DISCHARGE FROM SURFACE FLOAT VELOCITY MEASUREMENTS

A method of determination of discharge for float measurements where the upstream and downstream position of the floats has been estimated, is described in ISO 748 on float measurement, which is summarised as follows:

1. The upstream and downstream cross-sections are plotted as shown in Figure 6.22(a), and then divided into a suitable number of segments of equal width, the cross-sectional area of each of these segments can be determined.
2. Halfway between the two cross-section lines, another line MN shall be drawn parallel to the cross-section lines. The starting and end positions of each float may be plotted and joined by firm lines, while the surface-points separating the various panels of the two cross-sections may be joined by dotted lines.
3. When the firm lines cross the line MN, the corresponding mean velocity (float velocity  $v_{s,i}$  multiplied by the float coefficient  $c_f$ ) shall be plotted normal (at right angles) to MN and the end points of these velocity vectors joined to form a velocity distribution curve (Figure 6.22(b)).
4. The mean area of corresponding segments of the upper ( $A_i'$ ) and lower cross-sections ( $A_i$ ), when multiplied by the mean velocity for this panel as shown by the velocity distribution curve represents the discharge through the segment.
5. The summation of the discharges for all the segments is equal to the total discharge.

Hence:

$$Q = \sum_{i=1}^n \bar{v}_i \frac{A_i + A_i'}{2} \quad \text{where : } \bar{v}_i = C_f v_{s,i} \quad (6.6)$$

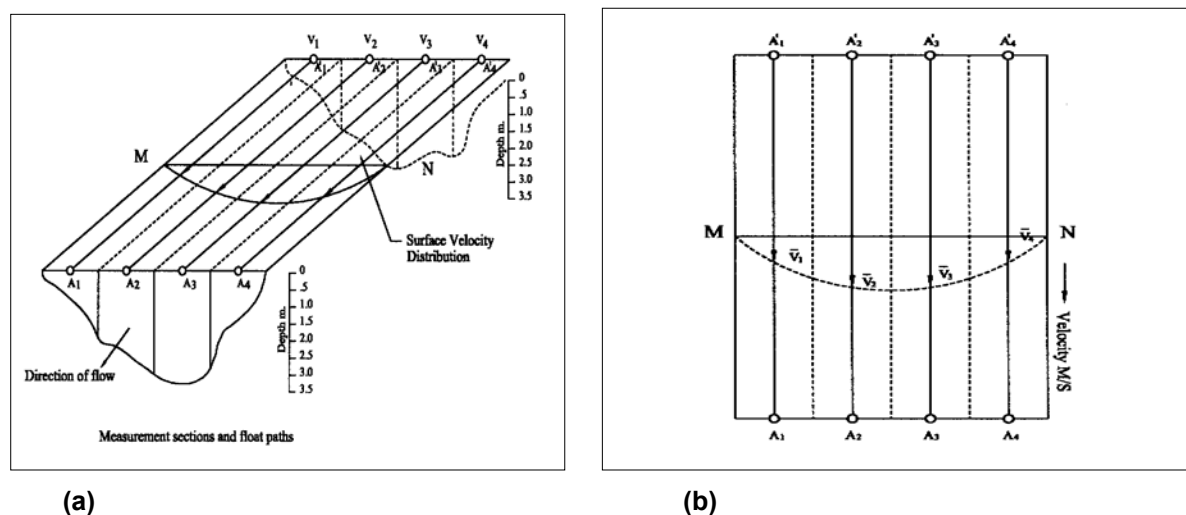

(Source: ISO 748)

Figure 6.22: Determination of discharge from surface water float measurements

Sometimes it is impossible to position the floats at reasonable intervals across the whole width of the river, e.g. in a wide river where there is no bridge there might be no means of distributing the floats across the full width of cross-section. In such circumstances a float coefficient should be applied which relates the average of the measured float velocities to the average cross-sectional velocity. This coefficient should be determined whenever possible, on the basis of mean cross-sectional velocities determined by current meter gaugings carried out simultaneously with float measurements. This gauging or gaugings should be undertaken at flows, which are as close as possible to those at which float measurements will be made. I.e. estimate for the current meter gauging of a similar or nearest magnitude how the float velocity estimate for a similar positioning of floats compares with the mean current meter gauged velocity for the whole cross-section and estimate the coefficient accordingly.

When it is only possible to measure flows in mid-stream along the approximate line of maximum velocity there are some approximate float coefficients, which can be applied to obtain a rough estimate of the mean velocity in the cross-section. These vary according to the depth of flow, see Table 6.2

Average depth in reach (m)	Coefficient
0.3	0.66
0.6	0.68
0.9	0.70
1.2	0.72
1.5	0.74
1.8	0.76
2.7	0.77
3.7	0.78
4.6	0.79
6.0	0.80

Table 6.2: Approximate float coefficient for mid-stream observations

In locations where normally the current is gauged from a boat and float measurements only take place when the flow velocities become too high for safe boat measurements, the velocity profile for the boat gauged stages will be known in detail. Then the velocity profile for the highest boat-gauged stages can be upscaled (see Figure 6.23) to match with the float measurements. Manning's formula can be used to scale the profile in proportion to 2/3 power of the local depths in the cross-section:

$$\bar{v}_2 = c_2 \bar{v}_1 \left( \frac{h_2}{h_1} \right)^{2/3}$$

$$\text{Where } c_2 \text{ follows from } c_2 = \left( \frac{\bar{v}_2}{\bar{v}_1} \left( \frac{h_2}{h_1} \right)^{2/3} \right)_{\text{float locations}} \quad (6.7)$$

where:  $\bar{v}_2$  = depth averaged velocity on estimated profile  
 $\bar{v}_1$  = depth averaged velocity from boat measurement  
 $h_2$  = local depth during float measurement condition  
 $h_1$  = local depth during boat measurement  
 $c_2$  = correction factor, covering changes in (n) and (S)

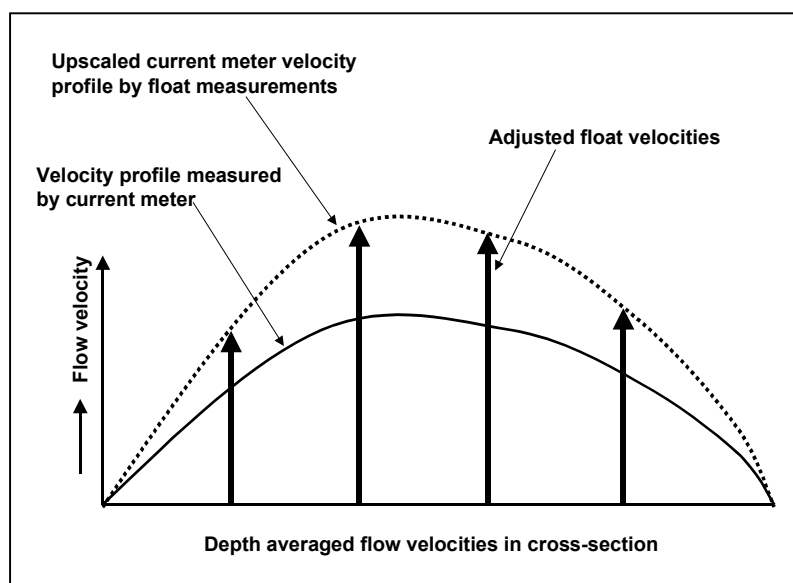

Figure 6.23:  
Estimation of cross-sectional  
velocity profile by upscaling from  
boat measurement

By estimating in this way the velocities at the boat measurement locations in the cross-section the same computational procedure as for the boat measurements (mid-section method) can be applied. It is strongly recommended to plot the entire velocity profile to trace anomalies.

The previous procedure assumes that the float measurement track covers the boat measurement site and that the riverbed does not change drastically. It is advised to select the float tracks at such locations in the cross-section where the transversal gradient of the flow velocity is not extreme to improve on the accuracy.

## 6.4 CURRENT METER STREAMFLOW MEASUREMENT

### 6.4.1 INTRODUCTION

There are two types of current (point velocity) meter which are, or could be, used in India. There is the well-known rotating element (impeller or cup type) meter and the electromagnetic current meter. The majority of this section concentrates on conventional rotating element current meters, associated equipment measurements and techniques and how they are used to estimate discharge. A two directional electromagnetic current meter has been specified as one of the main items of equipment for use in the moving boat method (see Chapter 7) so a brief description of this meter's operating principles are referred to later in this section for completeness.

### 6.4.2 ROTATING ELEMENT CURRENT METERS

The rotating element current meter is the most commonly used method of streamflow velocity measurement. It is currently the best-proven method available for deriving stage-discharge relationships and checking the performance of structures and other methods of flow measurement. The current meter consists of an impeller, vanes or cups (buckets) which are rotated by the velocity of the water.

The rotating element current meter operates on the proportionality between local flow velocity and the local angular velocity of the meter rotor. The relationship between velocity and rotor speed is usually established experimentally by towing the meter at various velocities through sensibly still water and recording the revolutions of the rotor, the distance travelled, and the times of each i.e. the speed of the towing carriage is assumed to be the equivalent of water velocity. Calibration usually takes place in rectangular tanks about 100m in length, 2m wide and 2 m deep. The meters are generally



suspended from a rod or a cable and attached to a trolley, which tows them through the water. The method of suspension used for calibration purposes should be the same as that to be used in the field. If a meter could be deployed in the field from either a wading rod or a suspension cable, then two separate calibrations should be derived for each method of deployment. During the calibration tow runs it is important that the supporting structure does not vibrate more than it would for the same velocity when deployed in the field.

The calibration relationship is usually of the form:

$$v = a + bn \quad (6.8)$$

where:  $v$  = water velocity (m/s)  
 $n$  = speed of impeller (revs/s)  
 $a, b$  = constants

Normally the current meter calibration consists of at least two equations of the above form. This is because there is a minimum response speed below which the meter will not turn, see Figure 6.24).

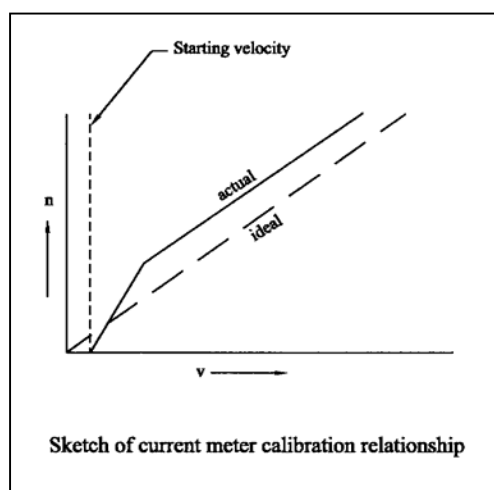

Figure 6.24:  
 Sketch of current meter calibration relationship

Over a period of time the current meter rating may change as a result of accidents such as damage to impeller shafts and cups or wear and tear, particularly during harsh Monsoon conditions. These changes might be quite small at higher velocities but may change significantly at low velocities. It is strongly recommended that current meters are calibrated and serviced regularly. Recommended is to re-calibrate the current meters **the minimum of 300 hours or 90 working days of use**. At the very worst, current meters should be re-calibrated **at least once a year** between each Monsoon season i.e. after a season of heavy use but prior to the next season of heavy use, **or after 300 hours of use, which ever occurs first**. The calibration of current meters is covered in more detail in Maintenance and Calibration, Part VIII of Volume 4, Field Manual, Hydrometry,

### **Limits of use**

Each current meter has a minimum response speed below which it is not possible to measure velocity. This is dependent on the type of meter and the shape of the impeller but is usually not less than 0.03 m/s. At slow velocities just above the minimum response speed the uncertainty is greater than at higher velocities. International standards recommend that **the minimum operational speeds shall not be less than 0.15 m/s**.

The current meter will have an upper limit (maximum velocity) beyond which it will not have been calibrated. **Use in flows with velocities greater than the maximum calibration velocity should be avoided.**

Some current meters such as the Ott can be supplied with a range of impellers with different helix pitches and diameters for use in a variety of conditions. **Each impeller should have its own unique calibration applicable to the current meter body it was calibrated on.** This approach should apply to all rotating element sensors.

### ***Turbulence***

Current meters are usually calibrated in still water but used to measure the velocity of turbulent flow. Turbulence imposes a circular motion on the linear motion of water past the meter. Little is known about the effects of turbulence on the calibration characteristics of current meters as the effect depends on the size of the eddies and the relative importance of circular motion compared with linear motion. Whenever possible the less turbulent sections of a river reach should be selected for current meter gauging.

### ***The Ideal Current meter***

An ideal current meter should have the following characteristics:

1. Instantaneous and consistent response to velocity changes;
2. Response only to velocity components perpendicular to the measuring section;
3. Durability;
4. Simplicity in construction and operation;
5. Low drag;
6. Self cleaning;
7. Rating tolerant of method of suspension.

### **6.4.3 TYPES OF CURRENT METER**

Rotating element current meters operated in India can be divided into two main types:

1. Vertical-axis meter - cup/buckets
2. Horizontal-axis meters - helical screw (impeller)

Examples of both these types of meter are shown in Figure 6.25. The vertical axis cup or bucket type meter is the most widely used current meter in India. Both types of meter have their advantages and disadvantages. However, if they are maintained well and deployed correctly then they should give satisfactory performance and results.

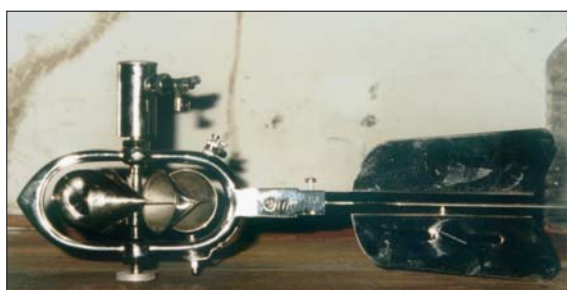

*Figure 6.25(a): Cup types current meter*



*Figure 6.25(b): Propeller type current meter*

### ***Cup-type current meters***

Characteristics of the cup-type current meters are summarised below:

1. This is a fairly robust instrument, which is widely used in India.
2. It is reported to operate at slightly lower velocities than impeller meters.
3. The bearings are well protected from silt water.
4. The buckets and axis are more susceptible to damage by floating debris than impeller meters.
5. A single rotor serves for the entire range of velocities.
6. The tail fin is very short, when used on a suspension cable they tend to move about the axis of flow more than impeller meters.
7. When held rigidly on a rod at right angles to the measuring section, the meter will tend to register the maximum velocity rather than the component velocity normal to the cross-section.
8. When supported by a cable the meter will measure the actual maximum oblique velocity provided it is free to align itself with the stream and it is properly balanced.
9. Some makes of cup meters have a protection bar in front of the cups. This could result in a different result depending on which direction the meter is positioned relative to the flow.
10. The cups will move due to vertical components of velocity. Therefore the up and down movement of a boat and/or suspension cable can cause inaccuracies.

### ***Impeller meters***

The impeller meters have following characteristics:

1. The impeller meter disturbs flow less than a cup type meter;
2. The impeller is less likely to be come entangled with debris than a cup type meter.
3. Bearing friction is less than for vertical shaft meters since the bending moment on the rotor is eliminated.
4. Some makes of meter come with a set of impellers to cover different velocity ranges (**note**: each impeller and corresponding meter body should have its own unique current meter calibration).
5. Most modern impeller meters have component (cosine response) impellers. This means that if they are held rigidly at right angles to the flow they should measure the component velocity normal to the measuring cross-section.
6. When supported by a cable the meter will measure the actual maximum oblique velocity provided it is free to align itself with the stream and it is properly balanced.
7. When used from a suspension cable, impeller meters appear to be more stable and rotate less about the direction of flow than cup meters.
8. Impeller meters are not so susceptible to vertical components of velocity as cup meters and therefore tend to give better results when used from moving boats.

### ***Care and checking of current meters***

Current meters are **scientific instruments**. They should be handled with care and operated and maintained in accordance with the manufacturer's instructions.

Care should be taken to ensure that the impeller and impeller shaft are not damaged. If this occurs the meter shaft and impeller should be replaced and the meter re-calibrated. Those meters with bearings in oil should have the oil changed at least after every day of gauging. Also, the meters should be housed in oil even when they are not in use.

**Spin tests** should be undertaken before each day of use. These should be undertaken in a draught proof environment. The meter should be spun three times by blowing along its axis. The time taken from top speed to standstill shall be observed and the average of the three readings taken. This should be compared with a spin test undertaken on receipt of the meter from the manufacturer when new or after each service and re-calibration. If a significant difference is noted (>10%) the meter should be investigated i.e. repeatability is very important. It is preferable that the same person is responsible for the spin tests on the same meter for consistency purposes. Some Indian Organisations have developed electro-mechanical spin test devices in order that the velocity of air moving the current meters rotating element remains relatively constant for each test.

**Notes:**

1. It is not a good idea to spin meters (particularly miniature ones) with the finger as this could damage the spindle.
2. Some meters e.g. Valeport, have water lubricated base bearings. Therefore, a standard spin test in the dry should not be applied to these meters.

When not in operation meters should be kept securely in their carrying box or case. Meters should **not be** carried or left somewhere when unprotected. Further discussion on the care and maintenance of current meters is contained in Volume 4, Field Manual on Hydrometry.

**Revolution Counting and Timing**

Revolution counters can either be electro-mechanical or electronic counting devices. The simplest counter, which is still widely used in India, makes a bleeping noise at every revolution. The operator counts the number of bleeps by listening by means of headphones. The time is measured simultaneously by means of a stopwatch. **It is recommended that the use of this type of counter is phased out since operator miscounting is a potential source of error.**

Other devices measure revolutions only, by means of a simple electro-mechanical or digital (LCD display) and a separate timing device (stopwatch) is required. If a simple counter is used it is essential to synchronise the counting and timing. The actual time over which the revolutions were monitored should be recorded and not the target time. e.g. if the target time was 60 sec. but the counter was stopped at 59.5 sec. then the latter should be recorded on the field record sheet.

More sophisticated counters have in built timing devices and these are to be preferred. These in built timers allow the pre-setting of an appropriate exposure time e.g. 60 seconds. Some devices also have an additional facility where the number of pulses can be pre-set and the time recorded.

Revolution counters and timers should be checked on a regular basis. The counter is normally checked against 50 revolutions of the impeller. If it does not record the correct number of revolutions it should be taken out of operation until such time as the problem has been resolved. Timers should be checked against a suitable calibrated timing device over say a 200 second period. **Differences of greater than 2.5% shall be investigated.**

**Exposure time**

Exposure time is the time over which the current meter revolutions are counted. The exposure time to be selected will be dependent on the physical characteristics of the river channel being monitored. However, it is important that the time selected is sufficient to minimise errors due to **pulsations**. Conversely if the discharge is changing rapidly the time selected should not be too long.

Generally for most Indian applications it is recommended that a **minimum exposure time of 60 seconds** be adopted. It should be noted that on some very large rivers under certain flow conditions, a longer exposure time might be appropriate.

If the velocities are very low and there are less than 20 counts in 60 seconds the exposure time should be increased to 100 seconds. Alternatively the time it takes to record 20 revolutions should be measured.

In situations where the stage is varying rapidly it is possible that the exposure time could be reduced to 30 seconds. This is discussed further in Volume 4, Field Manual on Hydrometry.

#### **6.4.4 METHODS OF SUSPENSION AND DEPLOYMENT OF CURRENT METERS**

Current meters can be fixed to rods or suspended from cables or handlines. If a suspension cable or handline is used a sinker weight and tail fin is required to be attached to the current meter.. The weight and shape of the sinker weight will be determined by the type of current meter, the method of deployment and the velocity of flow. Where high velocities occur it will only be possible to immerse the current to meter to just below the water surface (say 1.0 m) using a handline and at extremely, high velocities the same could apply, depending on sinker weight size to mechanically/electro-mechanically operated suspension cables.

**Current meters should be calibrated while fixed or suspended in the same manner which they will be used in the field.**

There are a number of methods of deploying current meters, which are summarised as follows:

1. Wading (see Figure 6.26)
2. From a bridge using rods (low bridge), handline or suspension derrick (bridge outfit) and winch (see Figure 6.27)
3. Cableway gauging - bank operated winch method, manned trolley (winch and cradle) method (see Figures 6.28, 6.29 and 6.30)
4. Boat gauging - stationary (including boat cableway) or moving boat methods.

#### **Note**

Cableway gauging normally refers to the construction of a cableway to transport a trolley across a river. The trolley can be designed to carry a man who operates the current meter while on the trolley. Alternatively, the trolley and the current meter can be operated by means of the winch system from the bank. These will be referred to as manned and unmanned cableways respectively. One of the most common ways of gauging large rivers in India is by means of a boat, which is positioned and secured by means of a cable, or rope attached to a cableway system. As the current meter is operated and controlled from the boat it is considered to be a boat gauging method and for the sake of clarity will be referred to as the boat cableway method.



Figure 6.26:  
Wading gauging



Figure 6.27: Gauging from a Bridge with a Bridge Outfit

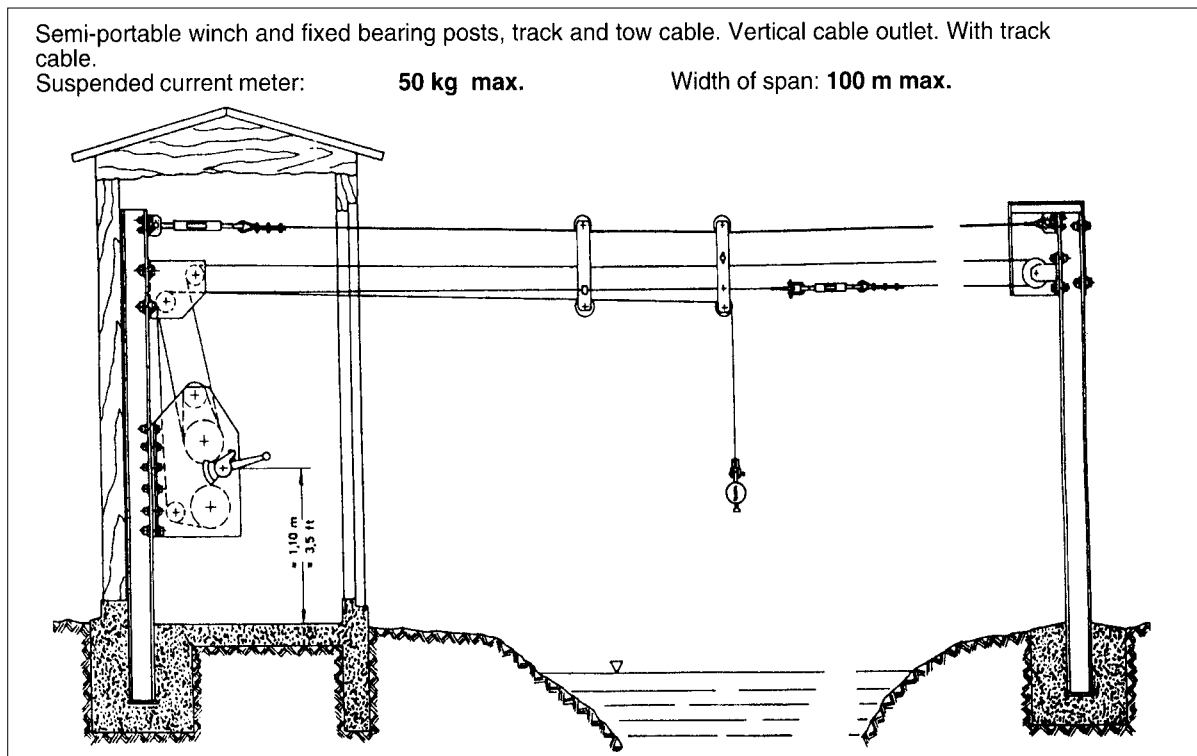

Figure 6.28: Unmanned Cableway System



Figure 6.29(a)



Figure 6.29(b)



*Figure 6.29(c):  
Unmanned cableway winch (manually operated and electrically operated)*



*Figure 6.30:  
Cableway with manned trolley*



*Figure 6.31:  
Boat gauging using a standard tag line method*





*Figure 6.32:  
Boat gauging - boat cableway  
system*

The selection of the gauging method depends on the following factors:

1. Physical characteristics of the site
2. Frequency of gauging
3. Required accuracy
4. Speed of operation/time availability
5. Staffing levels required
6. Cost
7. Importance of the site i.e. value
8. Safety considerations

**Wading gauging** is the simplest, usually the least costly and the quickest method of gauging. In shallow rivers and streams it can usually be undertaken by one person. Also, in many instances it can produce the most reliable results. The position of the operator is important - they must ensure that his/her body does not interfere with the flow pattern (see Volume 4, Field Manual, Hydrometry). Precautions must be taken, that the wading person is not carried/washed away at sites where flow is fast or changes rapidly.

**Bridge gauging** where wading gauging is not possible, bridge gauging is sometimes the next best alternative even though conditions are not always ideal e.g. skew flow conditions being created by the bridge piers. Single or limited span rectangular cross-section bridges, which do not cause a constriction to flow, are the best type of section. The current meter is suspended from the bridge by means of a handline or suspension derrick and winch (bridge outfit).

**Cableways** are usually installed as permanent fixtures at gauging stations for establishing stage-discharge relationships. There are two basic types of cableway:

1. Those with an unmanned instrument carriage or trolley controlled by river bank operation; and
2. Those with a manned carriage or trolley from which the observer controls the positioning and utilisation of the current meter.

Portable and semi-portable cableway systems do exist but these would only be appropriate for use at temporary or short term sites on smaller water courses such as those found in the Western Ghats.

Note: Boat cableway systems are considered and discussed in the relevant sections on boat gauging.

**Boat gauging** is usually used where it is not possible to gauge using one of the other three methods such as wide, deep channels. Boat gauging is usually undertaken by stretching a rope or cable across the measuring section to which boat can be attached either or not using an anchor to keep the boat in position. For very wide rivers the boat is kept in position using its engine and/or anchor. If a cable is used it can be marked off in distance measuring units (m) in order to ascertain the boats position across the cross-section. Alternatively, a survey technique or GPS can be used. Suspension of the current meter is normal by means of a small suspension derrick and winch. However, in shallower water rods can sometimes be used if the velocities are not too large.

An alternative to keeping the boat stationary at each vertical (conventional method) is to employ **the moving boat method**. This is more complicated than conventional boat gauging, but particularly with the advent of modern measuring instrumentation, it is a useful method of gauging larger, important rivers. However, it is possible that the technique will be superseded by the use of Acoustic Doppler Current Profilers (ADCPs), particularly if these reduce in price.

**Boat gauging in particular has a number of risks associated with it, particularly at high flows. Therefore, it is essential that safety procedures are in place and adhered to.**

General equipment specifications for the different current meter gauging methods are described in Chapter 7.

#### 6.4.5 SPACING OF VERTICALS

To be able to describe the bed shape, to determine the cross sectional area and to define the velocity distribution, the cross section is divided by verticals into segments. The spacing and number of verticals is crucial for the accurate measurement of discharge. The number of verticals is determined by the size, shape and regularity of the velocity profile across the measuring section. If too few verticals are used this can cause the largest source of error in the estimation of discharge by current meter gauging. The CWC specifies a minimum of 15 verticals except for channels with a width greater than 180 metres when a maximum of 25 is specified. ISO 748 and other standards specify criteria similar to these, see Table 6.3:

Channel width (m)	Number of verticals
$0 < W < 0.5$	3 to 4
$0.5 \leq W < 1$	4 to 5
$1 \leq W < 5$	5 to 8
$3 \leq W < 5$	8 to 10
$5 \leq W < 10$	10 to 20
$W \geq 10$	20

Table 6.3: *Recommended number of verticals as a function of channel width (ISO 748)*

---

**Notes**

1. Two additional verticals not included in the table are required close to each of the two waters edges.
2. In all instances depths and velocities made at the waters edge are additional to above.
3. The difference in depth between two adjacent verticals should not exceed 50% of the smaller.
4. The difference in velocity between non-zero samples taken at the same proportion of depth in adjacent verticals shall not exceed 50% of the smaller.

Generally such standards should be considered as a minimum requirement, rather than an upper limit.

For rivers in India greater than 10 m wide it is recommended, in line with ISO 748 and other practice, that at least 20 verticals be used and that the discharge in any one segment does not exceed 10% of the total. Between 20 and 30 verticals will normally be used. Uncertainties in streamflow measurement are expressed as percentages. The percentage uncertainty of using say 25 verticals is of the same order for all widths of river, irrespective of the width of segments. Verticals may be spaced on the basis of the following criteria:

1. Equidistant
2. Segments of equal flow
3. Bed profile i.e. where significant changes in depth occur

Experiments indicate that in terms of the overall uncertainty in discharge determination, there is no advantage in using segments of equal flow rather than equidistant segments. Because of the additional work in preparing the gauging section and in computation, it is recommended that the selection of verticals based on equal flow segments be not attempted.

For practical reasons, equidistant verticals will normally be used but with a larger number per section when the bed profile and velocity distribution is irregular. In the case of sudden changes in depth and velocity (changes > 50% of the smaller), one or more intermediate verticals may be added.

Special care has to be taken when **selecting the number or verticals used for bridge gauging**. For some types of bridges under certain flow conditions the current meter will be by necessity deployed between the bridge piers i.e. the position of the bridge piers relative to the current meter can be such that each bridge span or arch acts effectively as a separate channel. Some bridges have a large number of spans and in many cases this could result in only one velocity measurement being taken between each span. To treat each bridge span as a separate channel requiring upwards of 10 verticals per span would at most sites be too time consuming. Therefore, as a compromise it is recommended that 5 verticals should be taken between each bridge span including one at each edge\*. If this is not possible then an absolute minimum of 3 should be taken i.e. one at each edge and one in the middle. If the location of the current meter is such that it is located sufficiently far upstream or downstream of the bridge piers e.g. where the bridge deck is cantilevered, then the number of verticals can be selected as normal.

After a sufficiently long period of time covering the full range of flow conditions it could be demonstrated that it might be possible to reduce the number of verticals used at a gauging site without significantly reducing the accuracy. This should only be done on the basis of an analysis of the available gauging data. This might be particularly useful in situations where the stage is changing rapidly and time availability in which to complete the gauging is short.

**Note**

While it is important to be as close to the side of the bridge pier as possible one also has to consider the instrument safety. Therefore, care should be taken to ensure that there is a low risk of the instrument hitting the side of bridge piers.

**6.4.6 MEASUREMENT OF WIDTH, HORIZONTAL DISTANCE OR POSITION IN THE HORIZONTAL**

The measurement of the width of the channel and of individual segments or finding the position across the river relative to a fixed reference, are obtained by measuring the distance from or to a fixed reference point on the river bank. The technique selected depends on the width of the channel and the method of deployment used for gauging. In this sub-section techniques are discussed for:

1. Wading gauging
2. Bridges
3. Fixed cableways with bankside winch (unmanned instrument carriage)
4. Fixed cableways with cable car (winch and cradle/manned trolley)
5. Boat, including the following techniques:
  - Pivot point method
  - Linear measurement methods
  - Angular method
  - Stadia method, and
  - Geographic positioning system

***Wading Gauging***

When channel widths are small (say < 50 metres) these distances can be measured directly. For example by means of a tape or suitably marked wire (tag line) fixed across the measuring section. This method is recommended for gauging in narrow rivers and provides easy opportunity for selection of vertical spacing appropriate to channel width. The tape or tag line should be maintained as taut as possible. For wider wading gauging sections one of the positioning techniques for boat gauging described below could be used. Wading gauging is often deployed in India during the low flow season, when one of the other methods of deployment is not possible due to low depths. In many rivers the low flow does not flow across the whole bank full width of the river and in mobile (sandy) bed situations might flow in two or more distinct channels. In such circumstances each individual channel should be gauged separately and summed to give the total flow.

***Bridges***

Bridges used for gauging should be marked in advance on the bridge deck or parapet, showing also the position of bridge piers and abutments. As bridges are not generally designed for gauging purposes, gauging conditions may not be ideal, due to the influence of piers and other obstructions on the distribution of velocities (see Sub-section 6.4.5 regarding the number of verticals required). The marks should be sufficiently frequent to allow sufficient verticals to be taken when the width of flow is at a minimum.

### ***Fixed Cableways with bankside winch (unmanned instrument carriage)***

For fixed cableways where the current meter is traversed across the river using a bankside winch, it is recommended that all such winches be fitted with a counter based on the diameter of the cable drum to determine the distance traversed from the bankside reference point where the counter is zeroed. Such winch counters again allow adjustment of vertical spacing to changing channel width. If this is not possible then there should be a reliable and accurate method of measuring out the length of cable i.e. distances traversed by the trolley.

### ***Fixed cableways with cable car (winch and cradle/manned trolley)***

For fixed cableways used either with man-riding cable car or for positioning a boat in the channel, the cable is marked with tags, pendants or painted marks. Practice in some state networks has been to mark only 20 verticals at equal intervals across the channel width. This practice results in a decreasing number of segments with flow, as the channel width declines and consequently increasing uncertainty in discharge determination in low flows. It is recommended that the line be tagged at more frequent intervals, say 60, across the full channel width. In addition to ensuring adequate verticals in low flow, this practice allows alternate verticals to be used in successive gaugings, thus reducing the possible systematic bias in discharge deriving from the sampled verticals.

### ***Boat***

The fixing of verticals for gaugings by boat in rivers of moderate width can be done by using a moveable winch-mounted tag line. The tag line is wound on a reel which is operated from the stern of the boat, whilst on the bank the slack of the cable is taken up by means of a block and tackle with an anchored support. The line serves the dual purpose of holding the boat in position and of locating the measurement vertical. Alternatively portable fencing winches and marked cables can be used.

Where a boat cableway system is used the cable should be clearly marked with distance markers. The frequency of these marks should be sufficient to obtain at least 20 verticals at the lowest flow width. As the cable is often a significant distance above the boat, the marks should be clearly visible. At larger intervals (say every 10m or 50 m, depending on the width of river, it is advisable to have a different coloured or type of marker to avoid mis-positioning.

Where the river is too wide for the use of a tag line or boat cableway system or it cannot be used because of river traffic a variety of position fixing methods using bankside flags and targets may be used. These are briefly described below:

**Pivot Point Method.** A popular and effective method, which is widely used in India is the **pivot point method**, illustrated on Fig 6.33 and can be used so long as the river is wide and there is sufficient flat land available adjacent to the river. The cross section line is defined by points A and A'. The point A should be approximately half the river width from the water's edge. The line AP is laid at right angles and also a distance of approximately half the river width to the pivot point P. The line PD is about one fifth of AP and the line DD' is drawn parallel to the section line. On DD' points are marked at fixed and equal intervals depending on the width between the selected verticals. The boat moving on the line AA' can be fixed in the selected vertical by lining up points E<sub>1</sub>, E<sub>2</sub> etc. with P. If a river is wider than 600 metres pivot point layout may be used on both banks to enable two gauging parties to work simultaneously and independently. The points E<sub>1</sub>, E<sub>2</sub>, etc. may be defined by masonry blocks with a central pipe to hold the marker flag or ranging rod. There should be facilities for intermediate flag points to provide adequate verticals in the low flow channel.

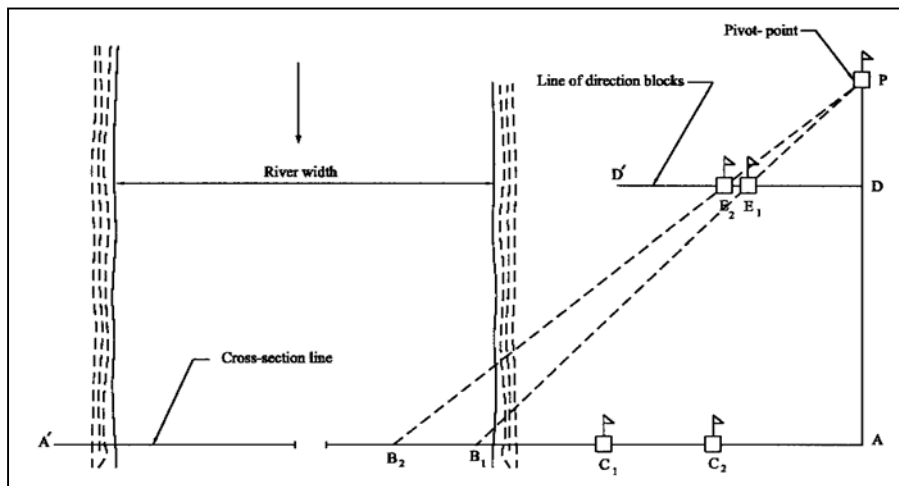

Figure 6.33: Diagram illustrating the pivot point method

(Source ISO 748)

**Linear Measurement Methods.** Two methods are referred to in ISO 748, these are as follows:

1. Four flags or markers A, B, C and D are fixed, two on each bank along the cross-section line (see Figure 6.34). One more flag, E, is fixed on one of the banks along at right angles to the cross-section line and passing through flag point B, nearer to the water's edge at a known distance from it. An observer with flag in his hand, then moves along the bank from C, towards a position N, along a line perpendicular to the cross-sectional line, until the corresponding flag E on the opposite bank, the flag on the boat M, and the flag in his hand N are all in one line. The perpendicular distance from the flag in his hand to the cross-section line is determined and the distance of the boat is computed as follows:

$$MC = \frac{CN \times CD}{BE + CN} \tag{6.9}$$

2. If the channel is very wide so that objects on the opposite bank are not clearly visible, the position of the boat is fixed from measurements made on one bank only (see Figure 6.35). Two flags on lines perpendicular to the cross-sectional line, and on the same side, are marked on one bank of the river such that the distance of the boat is computed as follows:

$$MD = \frac{DE \times CD}{DE - CN} \tag{6.10}$$

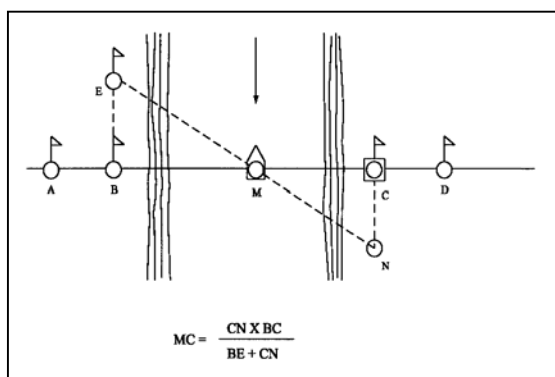

(Source ISO 748)

Figure 6.34: Measurement of position in cross-section - projection from opposite bank

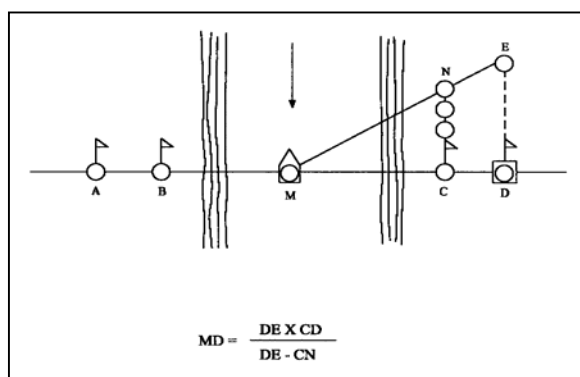

(Source ISO 748)

Figure 6.35: Measurement of position in cross-section – projection from one bank.

**Angular method.** A theodolite is set up on one of the banks and angular measurements taken to the boat used for taking soundings and its position fixed (See Figure 6.36). Alternatively, a sextant may be used from the boat to note the readings to two flags, one fixed on the cross-section and the other at right angles to it.

**Stadia method.** Where insufficient land is available or where ground very uneven for pivot point layout a **stadia method** may be used (see Figure 6.37). A theodolite or electronic distance measurer (EDM) is placed on the section line AD while the stadia rod or target is held in the boat and the distance is determined from the stadia readings or EDM readout.

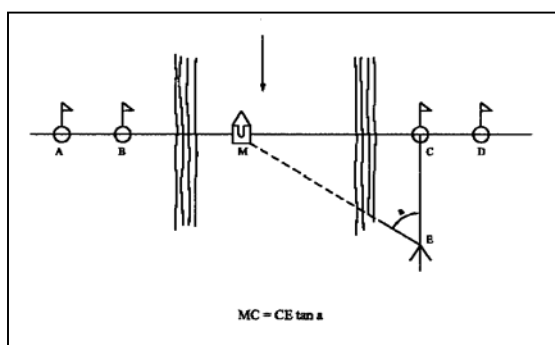

(Source ISO 748)

Figure 6.36: Measurement of position in cross-section - Angular method

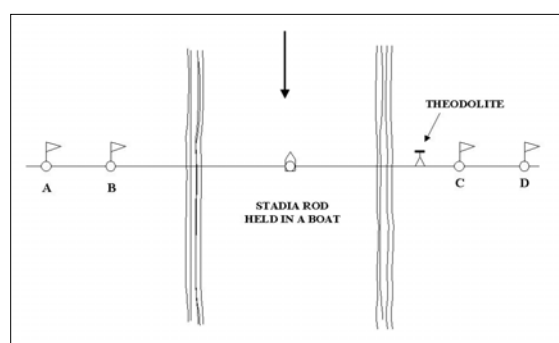

Figure 6.37: Measurement of position in cross-section - Stadia method

**Global Positioning Systems (GPS).** Modern global positioning systems can fix positions of boats to within 2 m. The technique is particularly suitable for use with the moving boat method but can also be used for the conventional boat gauging method. A specification for a GPS system is referred to in Chapter 7 with particular reference to its use for the moving boat method.

### Communication

For some of the above methods it is possible to have the inherent position visible to the boat driver. However, for others such as the shore based theodolite method this is not possible. Therefore, while moving the boat between positions the boat driver needs to receive information on the boat's position/movement relative to the required position. This information can be relayed by means of pre-determined and clear signals, megaphone, hand-held radio or portable phone.

## 6.4.7 MEASUREMENT OF DEPTH

### Pre-surveyed section

Depth and velocity are normally measured as successive operations during current meter gauging. However, it may be more convenient to survey the cross section accurately during low flow and, for every vertical used for velocity measurement to determine the difference between gauge zero and bed level ( $d_1 \dots d_n$ ). Approximately 60 points across the section should be used. During subsequent gauging, the depth  $h_i$  at the  $i^{\text{th}}$  vertical becomes the sum of the staff gauge reading and  $d_i$ . A reference chart may be prepared for use during gauging. Although pre-survey is generally more accurate than levels sounded during flood gauging, this method should only be used where there is evidence that there is no significant change in the bed level due to erosion or deposition between survey and gauging or where sounded depths cannot satisfactorily be obtained during floods. The cross section must be confirmed by post-flood or post monsoon survey. It is important using this method to be able to accurately determine the position in the horizontal relative to the original cross-sectional survey, otherwise there is a danger that the current meter will be positioned wrongly in the vertical and the horizontal.

The method of depth measurement during gauging depends on depth and velocity and whether done by wading, cableway, bridge or boat. Depth and position in the vertical are measured by rigid rod or by a sounding weight suspended from a cable provided that velocities are not too high. By whatever method at least two observations of depth should be taken at each vertical and the mean of the two values used for area and discharge computation.

Following techniques are discussed below:

- Wading rods
- Sounding rods
- Sounding reels and cables (including wet- and airline correction)
- Echosounder

### ***Wading Rods***

Whilst wading, the depth may be measured by rods up to a depth of about 1 metre. Rods with screw-in extensions may be used from boat or low bridge. They are usually circular in cross section and colour marked in metres, decimetres and centimetres. The rod is placed on the channel bottom at the selected vertical and the depth is read directly. Rods are provided with a detachable base plate to prevent sinking into the bed. However, if the bed is very soft or of mobile sand, thus not allowing firm placing of the base, it may be held in suspension by hand and the depth read when the base plate just touches the bed.

The **top-setting wading rod** has a main rod for measuring depth and a second rod for setting the position of the current meter. The advantage of this rod is that the current meter can be set at the selected depth in the water without getting the hands wet. The rod is placed so that the base plate rests on the bed and the depth of water is read on the graduated main rod. When the setting rod is adjusted to read the depth of water, the meter is positioned automatically at 0.6 depth. Top setting of 0.2 and 0.8 depth is also possible.

### ***Sounding rods***

For depths up to 6 metres sounding rods made from seasoned timber or bamboo may be cheaply made and used from river crossing or boat. Rods have painted graduations or enamelled graduation plates and a circular foot plate 15 cm in diameter to prevent sinking in the bed. A plumb bob is provided to ensure that the rod is placed vertically. Graduations on painted rods should be regularly checked for length accuracy by steel tape and paint markings renewed.

### ***Sounding reels and cables***

When the river is too deep or fast flowing to wade, the current meter is suspended in the water by cable from a boat, bridge or cableway. The cable is used with reels, winches and counters to measure the water depth and to position the current meter. The normal arrangement is for a weight hanger bar to be attached to the end of the sounding line by a connector. A sounding weight (sinker weight or bomb) is attached to the lower end of the hanger by means of a hanger pin and the current meter is attached beneath the connector.

When using the sounding reel and counter, the weight and current meter are lowered until the bottom of the weight touches the water surface and the counter is set to zero. The current meter assembly is then lowered to the streambed and the length of cable paid out is read from the counter and recorded. Where the reel is not equipped with a counter, alternative arrangements are made to measure the length of line paid out at the reel from water surface to bed. For example, graduations on the cable or if a suspension derrick is used on the derrick's jib. The observer can tell when the current meter touches the bed of the



river at lower velocities since the tension goes out of the suspension cable. However, as velocities increase this becomes more difficult to detect. Some more sophisticated current meter gauging systems have a sensor on the bottom of the sinker weight which transmits a signal back to the observer when the weight touches the bottom.

Once the depth measurement has been made the current meter has to be positioned at the correct depth(s) to take the velocity reading(s) e.g. 0.6D. Three ways of doing this are possible which are outlined below. In order to illustrate each of the three methods assume it is required to position the meter at 0.6D at a vertical where the depth is 2 m deep. The distance between the bottom of the sinker weight and the centre of the current meter is 0.25 m (h) i.e. effective length of hanger bar.

1. Measure the depth by zeroing bottom of sinker weight at surface and lowering it to the bottom. Then raise the meter back to the surface and position the meter axis at the water surface (not the sinker weight) and zero the depth counter or other depth measurement device. Then lower the meter to the required position i.e. 0.6D from the water surface.

Zero depth measurement device with bottom of weight touching water surface, then lower to bed and read measurement

Depth reading = 2.0 m.

Raise centre line of meter to water surface and zero depth counter or measuring device at this position, then lower until the reading is:

$0.6D = 0.6 \times 2 \text{ m} = 1.2 \text{ m}.$

2. Zero the axis of the meter at the surface, lower the meter until the sinker weight touches the bottom and measure the distance the meter has been lowered from the surface. Add the distance between the bottom of the weight to the centre line of the current meter to obtain the total depth. Then position the meter at the required depth.

Reading when weight touches bottom = 1.75 m

Depth = reading on counter + h = 1.75 + 0.25 = 2.0 m.

Position meter at 0.6D = 1.2 m

3. Zero the bottom of the weight at the surface of the water and lower it to the bottom to measure the depth. To position the current meter at the required position work out the required position and then add the distance between the bottom of the weight to the centre line of the current meter. Then position the current meter at 0.6 of this depth from the surface. If the meter is raised to this level on the counter or other distance measuring device it will be at the correct level

Reading on counter = 2.0 m

$0.6D = 1.2 \text{ m}$

Position of weight for meter to be at 0.6D = 1.2 + 0.25 m = 1.45 m

Therefore raise meter until reading on counter = 1.45 m i.e. this is the position of the weight.

The sinker weight, hanger bar, suspension cable (and in particular its diameter) and where not permanently attached, the tail fin should be in accordance with the manufacturers recommended specification i.e. the sinker weight etc. should be one which is supplied for the specific make of current meter.

### Wet line / Dry line corrections

The weight of the sounding weight needs to be sufficient to maintain the cable in an approximately vertical position. It is usually decided on by experience, and common weights in use vary from 7 kg to 150 kg depending on the velocity and depth.

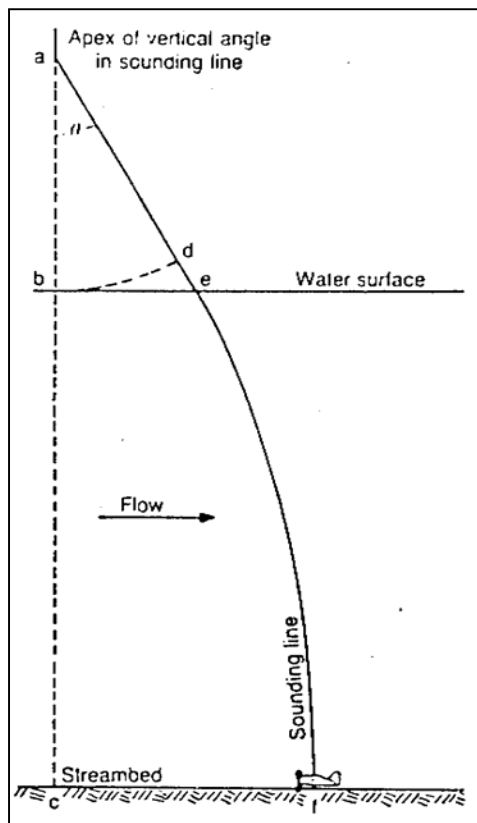

Figure 6.38:  
Sketch demonstrating the air line and wet line correction

Where velocities are high and the sounding weight is insufficient to maintain the suspension cable vertical, the length of cable paid out is always more than the true depth of water as shown in Figure 6.38. In order to obtain the corrected depth, dry line and wet line corrections, which are functions of the vertical angle  $\theta$ , are applied to the observed depth, where the angle  $\theta$  is measured by a fixed protractor.

$$\begin{aligned} \text{Observed depth} &= af - ab = df \\ &= \text{true depth} + (ae - ab) + (ef - bc) \end{aligned}$$

$$\text{Air line correction} = ae - ab = ab (\sec \theta - 1)$$

$$\text{Wet line correction} = ef - bc$$

**Air line correction:** allows for the difference between the slant length and the vertical line above the surface and the vertical; length of the line above the surface.

**Wet line:** allows for the correction of the wetted length of the wire when the wire is not normal to the surface.

The air line correction is the difference between the slant length of line and the vertical distance from the suspension point to the water surface. Correction factors are shown in Table 6.4 as a percentage of the vertical air line cable length. The wet line correction is applied to that part of the length of the sounding line below the water surface as also shown in Table 6.4. These values assume that the velocity distribution in the vertical is normal and that the drag forces near the bed can be neglected, but can be significantly in error where the vertical angle exceeds 30°.

The same conditions that cause errors in sounding the depth of the river also cause errors in placing the current meter at the selected depth in the vertical. The correction tables are not strictly applicable to the problem of placing the current meter because of the increased drag force as the current meter is raised from the stream bed. The use of the correction tables will tend to reduce this error, and although not strictly applicable, their use has become general for this purpose.

Vertical Angle $\theta$ (degrees)	% Correction	
	Dry line	Wet line
4	0.24	0.06
6	0.55	0.16
8	0.98	0.32
10	1.54	0.50
12	2.23	0.72
14	3.06	0.98
16	4.03	1.28
18	5.15	1.64
20	6.42	2.04
22	7.85	2.48
24	9.46	2.96
26	11.26	3.50
28	13.26	4.08
30	15.47	4.72

Table 6.4: Air line and wet line corrections

The routine procedure for applying depth corrections with reference to Fig 6.38 is as follows:

1. Measure the vertical distance  $ab$  from the guide pulley on the gauging reel to the water surface. This will give the vertical distance to be used with the air-line correction table.
2. Place the bottom of the weight at the water surface and set the depth counter on the gauging reel to read zero.
3. Lower the sounding weight to the bed of the stream. Read and record the sounded depth  $df$  and the vertical angle  $\theta$  of the cable when the weight is at the bed of the stream, but entirely supported by the cable.
4. With the aid of the correction tables compute and record:
  - the air correction ( $de$ ) as a percentage of ( $ab$ ) (Table 6.4);
  - the wet line depth ( $ef$ ) =  $df - de$ ;
  - the wet line correction as a percentage of ( $ef$ ) (Table 6.4);
  - add both corrections together and subtract them from the sounded depth ( $df$ ) - this will give the revised depth ( $bc$ );
  - if the 0.2 and 0.8 depth method is in use to locate the current meter for velocity measurement, raise the current meter from the sounding position at the stream bed a distance equal to 0.2 of the wet line depth ( $ef$ ) minus the distance from the current meter to the bottom of the weight - this places the current meter approximately at the 0.8 depth position;

- Raise the current meter to the surface of the water and set the depth counter to read (ae), then lower the current meter until it is at a distance equal to (ae) plus 0.2 of the wet line depth (ef) - this places the current meter approximately at the 0.2 depth position.

An **alternative** method can be used where there is a **pre-surveyed** cross-section:

1. Estimate the true depth in the vertical from the current water level and the position across the measuring section using the pre-determined cross-section;
2. Position the meter at the required sampling depth assuming that the measured depth is correct. At extremely high velocities, the meter can be positioned just below the surface, say 1 m and the surface velocity adjusted to give the mean velocity in the vertical by means of an appropriate coefficient i.e. like a surface float coefficient.

When the drag is severe and the potential errors high, serious consideration should be given to the use of the pre-surveyed section method. It should also be noted that errors are particularly severe where the air line is long in comparison with the wet line and the angle  $\theta$  is high.

#### EXAMPLE 6.1 AIR LINE AND WET LINE CORRECTIONS

The total length of a sounding line when the sinker weight is touching the bed of a river = 7.55 m. The depth from guide pulley to surface = 3.0 m. The angle between the vertical and the sounding line at the point of suspension i.e.  $\theta = 20^\circ$ . The distance from the centre line of the current meter to the bottom of the weight = 0.3 m. What is the true depth of the vertical? Find the positions of the current meter for the two point method i.e. 0.2D and 0.8D.

Solution:

$$df = af - ab = 7.55 - 3.0 = 4.55$$

Air line % correction = 6.42% from Table 6.4

$$\text{Air line correction, } de = 6.42\% \times ab = 0.642 \times 3.0 = 0.19 \text{ m.}$$

$$\text{Wet line depth, } ef = df - de = 4.55 - 0.19 = 4.36 \text{ m.}$$

Wet line % correction = 2.04% from Table 6.4

$$\text{Wet line correction} = 2.04\% \times 4.36 = 0.0204 \times 4.36 = 0.09$$

$$\text{True depth} = df - \text{air line corr.} - \text{wet line corr.} = 4.55 - 0.19 - 0.09 = 4.27 \text{ m}$$

To place current meter at 0.8D:

$$0.2 \text{ wet line depth} = 0.2 \times 4.36 = 0.87 \text{ m}$$

Current meter should be raised a distance of 0.87 - 0.3 m from position when sinker weight is just resting on the river bed.

To place current meter at 0.2D:

$$ae + 0.2 \text{ wet line (ef) i.e. } 3.19 = 0.2 \times 4.36 = 4.062 \text{ m from suspension cable pivot.}$$

#### **Echo sounder**

Echo sounders are sometimes used for the determination of depth in deep water from a gauging boat or at high velocities when it is not possible to use a sounding line and sinker weight. The sounding transducer, mounted underwater, releases bursts of ultrasonic energy at fixed intervals and the instrument measures the time required for these pulses of energy to travel to the stream bed and to be reflected and return to the transducer. With the known propagation velocity of sound in water, the sounder computes and records the depth on a strip chart, dial, data logger or portable PC.

Use of an echo sounder removes the errors arising from drag on cables and accuracies of 1% are attainable in deeper water from both portable and fixed models. Accuracy reduces in shallower depths and the minimum depth for use is of the order of 0.3 metres. Errors can arise from the entrainment of bubbles under the transducer and from variations in the speed of ultrasound with changing temperature and salinity. If a survey vessel is used then allowance has to be made for the draft/difference between the water surface and the face of the transducer heads i.e. offset. In practice checks should be made during the working day using a check bar suspended at known depth below the sounder or by making simultaneous soundings by sounding line on a firm bottom. The operating frequency should be 200 kHz or higher to avoid penetration of the acoustic signal into the streambed.

The use of an echo sounder coupled with a GPS system is an excellent way of recording position and depth simultaneously and these two together form an essential part of the equipment required to undertake flow measurements using the moving boat method. Specifications for echo sounders are referred to in more detail in Chapter 7.

#### 6.4.8 SKEW EFFECTS

Current meter gauging requires the measurement of the horizontal component of velocity perpendicular to the cross-section at each point being sampled. As such river sections where horizontal (e.g. downstream of a bend) and/or vertical (e.g. at constriction) skew flow occur should be avoided. This is not always possible. For skew flows up to  $10^\circ$  from the perpendicular to the cross-section the error is relatively small provided the meter is held perpendicular to the measuring section. Modern impeller meters are designed to try and compensate for flow which is not normal to the measuring section. This is due to the cosine response.

However, cup meters tend to measure the maximum velocity as will impeller meters if they are pointing into the direction of flow when suspended from a suspension cable/line. Therefore for bucket meters or impeller meters pointing in the direction of flow and not the perpendicular, the following correction should be applied:

$$V_{\text{corrected}} = V_{\text{measured}} \times \cos \theta \quad (6.11)$$

where:  $\theta$  = the angle between the direction of flow and the perpendicular to the cross-section.

The angle  $\theta$  is not easily measured and as such the effect of skew flow is usually ignored. However, there are occasions when it is necessary to gauge from bridges which are not at right angles to the direction of flow i.e. they cross the river at an angle. In such circumstances the measured velocities should be multiplied by the cosine of the angle between the angle made by the perpendicular to the direction of flow (line of banks) and the line of the axis of the bridge. This is illustrated in the sketch below (Figure 6.39).

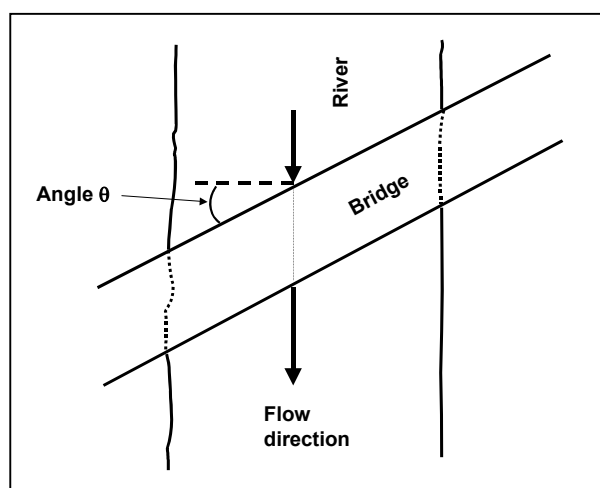

Figure 6.39:  
Sketch illustrating the effect of bridges skew to the direction of flow

When rod gauging is undertaken care should always be taken to ensure that the meter is held horizontal to the bed at right angles to the cross-section.

### 6.4.9 METHODS OF ESTIMATING MEAN VELOCITY IN THE VERTICAL

The measurement of discharge in open channels using current meter point velocity sensing devices, requires the determination of mean velocity for each sampling vertical across the measuring section. The mean velocity in each vertical can be determined by one of the following methods:

- Reduced-point methods
- Velocity-distribution method
- Other methods
- Integration Method

The **reduced point** and **other methods** are undertaken by taking velocity measurements at fixed proportions of the depth below the surface.

For the **velocity-distribution method**, velocity measurements are made in a number of points in each vertical between the surface and the bed of the channel. The spacing should be such that the velocity between two adjacent points is not more than 20% with respect to the higher of the two. The top and bottom points should be located near the top and bottom of the channel.

The **integration method** involves raising and lowering the meter through the entire depth at each vertical at a uniform rate. This method is not recommended.

The choice of method is dependent on the time available, the physical characteristics of the river, changing stage and the purpose for which the data are required. A summary of the application of these different methods is contained in Table 6.5.

The one (0.6D) (i.e. 0.6D from the surface or 0.4D from the riverbed!!) and two point (0.2D & 0.8D) methods are adequate for most routine fieldwork. The former being used for depths <1.0 m and the latter for depths  $\geq 1.0$  m. Generally, the 0.6D has been used in India for all depths. In some cases it is only possible to use the surface velocity method in which case the surface velocity is multiplied to a coefficient similar to that for a surface water float, say 0.85. Such coefficients should be confirmed by estimating the mean velocity by another method. An alternative to 0.6D is to position the current meter at 0.5D and multiplying the resulting velocity by 0.95 to obtain the mean in the vertical, which gives results which a slightly reduced error.

At important and/or difficult sites it is recommended that in the first instance the two point or even one of the other methods involving more points is used. If it can be demonstrated that the velocity distributions follow the logarithmic form then it would be possible to revert to the 0.6D, or possible even the 0.5D method.

**NOTE: In terms of reducing the overall uncertainty in the discharge measurement it is generally better to use more verticals than trying to measure more points in the vertical.**

#### EXAMPLE 6.2

Question: If the depth in a vertical is 2.0 metres at what level would you position the current meter using the one point and two point methods?

Answer: **One point method:**  $2 \times 0.6 = 1.2$  m  
i.e. 1.2 metres from water surface.

**Two point method:**  $2 \times 0.2 = 0.4$  m  
 $2 \times 0.8 = 1.6$  m  
i.e. 0.4 and 1.6 metres from the surface.

Method	Estimation	Advantages, disadvantages & limitations
<b>1) Reduced Point Methods</b> a) One point method b) Two point method	a) $v_m = v_{0.6}$ b) $v_m = 0.5 (v_{0.2} + v_{0.8})$	$D < 1.0\text{m}$ $D > 1.0\text{m}$ Provide reliable estimates of mean velocity provided the velocity distribution is regular and follows classical form.
<b>2) Velocity Distribution Method</b>	The velocity measurements in each vertical are plotted against decimal fraction of depth from the surface. The area under the curve which is equal to the mean velocity can be determined by digitiser, planimeter, or counting squares.	- Accurate but time consuming. - Not appropriate for rapidly changing flow conditions. - Most appropriate for research activities in rivers and open channels with irregular velocity distributions.
<b>3) Other Methods</b>		
a) Six point method	a) $v_m = 0.1(v_s + 2v_{0.2} + 2v_{0.4} + 2v_{0.6} + 2v_{0.8} + v_b)$	a), b) & c) used in difficult conditions such as sites with aquatic weed growth or for special research investigations or calibration work in irregular channels. Used where more information on vertical profile required or where there is some doubt about the regularity of the profile.
b) Five point method	b) $v_m = 0.1(v_s + 3v_{0.2} + 3v_{0.6} + 2v_{0.8} + v_b)$	
c) Three point method	c) $v_m = 0.25(v_{0.2} + 2v_{0.6} + v_{0.8})$	
d) Alternative one point method	d) $v_m = 0.95 \times v_{0.5}$	Sometimes used at shallow depths where it is not possible to fix the current meter at 0.6D or to avoid arithmetic errors.
e) Surface one point method	e) $v_s = c \times v_s$ c = coefficient, varying usually from 0.84 to 0.90. The value of the coefficient should be checked when possible by one of the other methods.	Used in flood, or other conditions where the other methods are not feasible. The depth of submergence should be the same across the cross-section e.g. 1 m.
<b>4) Integration Method</b>	The average number of revolutions per second over the integration period is determined and this is incorporated into the formula for the current meter calibration coefficient.	- Water depths > 1m. - Problem - maintaining steady lowering and raising speed. - Vertical components of velocity could cause errors. - Suspension methods only.

**Key:** v - velocity  
D - depth at vertical  
Subscripts:  
m - mean velocity  
s - velocity just below the surface  
0.2, 0.4, 0.5, 0.6, 0.8 - proportion of depth from surface e.g.  $v_{0.6}$  = velocity at 0.6D  
b - velocity just above bed

**Table 6.5:** *Methods of estimating mean velocity in a vertical*

### 6.4.10 LEGITIMATE SHORT CUTS

Under certain field conditions and circumstances it is permissible to take short cuts in the procedures when time is of the essence. In particular during rapidly varying discharge and stage conditions e.g. flood gauging. Under such circumstances it might be necessary to do one or more of the following:

1. Only measure velocities at, or close to the surface;
2. Reduce the number of verticals;
3. Do not measure depth, if a reference water level mark is taken, the cross-section can be surveyed at a later date;
4. If the site has been gauged previously it is possible that the knowledge obtained earlier can be used to reduce the amount of measurement time e.g. pre-determined cross-sections;
5. Reduce the exposure time.

This is discussed further in Volume 4, Field Manual, Hydrometry, dealing with the measurement procedures.

### 6.4.11 COMPUTATION OF DISCHARGE

There are several methods of computing flow from current meter gauging data. These are summarised as follows:

<b>Arithmetical</b>	<b>Graphical</b>
Mid-section	Velocity contour
Mean-section	Graphical integration method

The arithmetical methods are the most commonly used and one or other of them is usually the basis of most current meter gauging computational software. Of these the **mid-section method** is most widely used in India and is described below. Graphical methods are rarely utilised these days except for special investigations where multi-point methods are used and where there is a specific interest in the velocity distribution. For information on the other techniques the reader is referred to ISO 748 and other hydrometric standards and textbooks.

The computation of discharge using **the mid-section method** is illustrated by Figure 6.40.

In the mid-section method of computation, it is assumed that the velocity sampled at each vertical ( $v_i$ ) represents the mean velocity in a segment. Similarly it is assumed that the depth of the vertical ( $d_i$ ) is the mean depth in the segment. The segment area extends laterally from half the distance from the preceding vertical to half the distance to the next as shown as the hatched area in Figure 6.40.

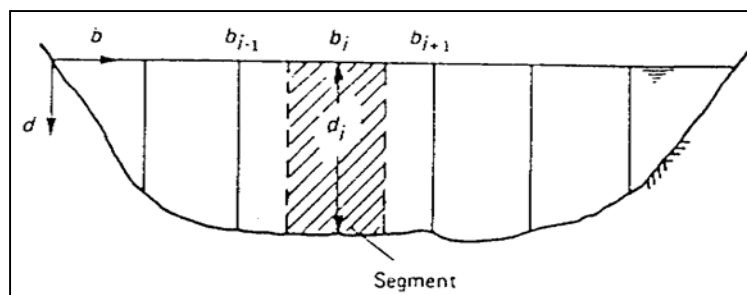

Figure 6.40:  
Sketch illustrating the computation of discharge using the mid-section method



The segment discharge ( $q_i$ ) is then computed for each segment and these are summed to obtain the total discharge as follows:

$$Q = \sum_1^n q_i = \sum_1^n \bar{v}_i \cdot a_i = \sum_1^n \bar{v}_i \cdot d_i \cdot \frac{(b_{i+1} - b_{i-1})}{2} \quad (6.12)$$

where  $b_i$  is the distance of the measuring point ( $i$ ) from a bank datum and  $n$  is the number of measured verticals and sub-areas. In the mid-section method flow in the end panels is usually neglected, and therefore the first and last verticals should be sited as near to the bank as possible.

#### 6.4.12 ERROR ANALYSIS VELOCITY AREA METHOD

With reference to equation (6.12) errors in the discharge computed by the area velocity method using the mid-section method are due to uncertainties in the width, depth, mean flow velocity in the vertical and the number of verticals. A detailed treatise on error analysis is presented in Volume 2, Design Manual, Sampling Principles. In this sub-section the theory will be applied to assess the uncertainty in the computed discharge. An extensive analysis is presented in ISO/TR 7178-1983: "Investigation of the total error in measurement of flow by velocity area methods" (ISO, 1983) and Herschy (1995).

##### *Error equation*

The overall uncertainty in the discharge as estimated by (6.12) is given by:

$$X_Q = \pm \left[ X_n^2 + \frac{\sum_{i=1}^n (b_i d_i \bar{v}_i)^2 (X_b^2 + X_d^2 + X_e^2 + X_p^2 + X_c^2)_i}{\left( \sum_{i=1}^n b_i d_i \bar{v}_i \right)^2} \right]^{1/2} \quad (6.13)$$

- where:  $X_Q$  = overall uncertainty in discharge  
 $X_n$  = uncertainty due to limited number of verticals  
 $X_b$  = uncertainty in width measurement  
 $X_d$  = uncertainty in depth measurement  
 $X_e$  = uncertainty due to pulsation in flow  
 $X_p$  = uncertainty due to number of points taken in the vertical  
 $X_c$  = uncertainty in the current meter rating

Note that the uncertainties due to the pulsation in flow, the number of points taken in the vertical and the uncertainty in the current meter rating, respectively  $X_e$ ,  $X_p$  and  $X_c$  constitute the uncertainty in the average velocity in the vertical.

Equation (6.13) can be simplified if the segment discharges as well as the various uncertainties in the segments are nearly equal. Then the random and systematic uncertainty in the discharge  $X'_Q$  and  $X''_Q$  respectively, are given by:

$$X'_Q = \pm \sqrt{X_n'^2 + \frac{1}{n}(X_b'^2 + X_d'^2 + X_e'^2 + X_p'^2 + X_c'^2)} \quad (6.14)$$

and :

$$X_Q'' = \pm \sqrt{X_b''^2 + X_d''^2 + X_c''^2} \quad (6.15)$$

so :

$$X_Q = \pm \sqrt{X_Q'^2 + X_Q''^2} \quad (6.16)$$

Approximate values for the various uncertainties as presented by Herschy (1995) are given in the Tables 6.5 to 6.10:

- Table 6.5, random uncertainty due to limited number of verticals,  $X'_n$
- Table 6.6, random uncertainty in width and depth,  $X'_b$  and  $X'_d$
- Table 6.7, random uncertainty due limited time of exposure,  $X'_e$
- Table 6.8, random uncertainty due to limited number of points in the vertical,  $X'_p$
- Table 6.9, random uncertainty in current meter rating,  $X'_c$
- Table 6.10, systematic uncertainty in width  $X''_b$ , depth  $X''_d$  and current meter rating  $X''_c$

It is noted that the values presented in the tables are mainly based on tests and analysis carried out all over the world (ISO, 1983). For a particular case values may be different. Actual values for the uncertainties have to be verified by the user.

#### ***Random uncertainty due to limited number of verticals $X'_n$***

The uncertainty  $X'_n$  is presented in Table 6.5. The uncertainty is large when the number of verticals is low. As is observed from (6.14) this is not the only effect the number of verticals has on the random error in Q; it also determines the contributions of all other errors, relative to  $X'_n$ .

Number of verticals	Uncertainties $X'_n$ (%)
5	15
10	9
15	6
20	5
25	4
30	3
35	2
40	2
45	2

Table 6.5: *Random uncertainty due to limited number of verticals*

#### ***Random uncertainty in width and depth $X'_b$ and $X'_d$***

The random uncertainty in width and depth is presented in Table 6.6. With respect to Table 6.6 note that ISO 748 indicates for the measurement of distance, a relative error of 0.3% for a distance between 0 and 100 m, and 0.5% for a distance of 250 m. When the distance is measured electronically, an error as a percentage of the distance (for instance 0.5 to 1%), in addition to a fixed error of 0.5 to 2 m, has to be considered. The instrumental error in the measured depth depends, to a

large extent, on the composition of the riverbed, which is critical if the sounding rod, lead or acoustic pulse of the echosounder penetrates into the bed.

Variable	Term	Uncertainty (%)
Width	$X'_b$	0.1 to 0.5 depending on the actual length
Depth	$X'_d$	1 to 3 depending on the actual depth

Table 6.6: Random uncertainty in width and depth

**Random uncertainty due limited time of exposure  $X'_e$**

Velocity (m/s)	Point in vertical: 0.2D, 0.4D or 0.6D				Point in vertical: 0.8D and 0.9D			
	Exposure time (min)							
	0.5	1	2	3	0.5	1	2	3
0.050	50	40	30	20	80	60	50	40
0.100	27	22	16	13	33	27	20	17
0.200	15	12	9	7	17	14	10	8
0.300	10	7	6	5	10	7	6	5
0.400	8	6	6	5	8	6	6	5
0.500	8	6	6	4	8	6	6	4
1.000	7	6	6	4	7	6	6	4
> 1.000	7	6	5	4	7	6	5	4

Table 6.7: Uncertainty due to limited exposure time in point in vertical in %

The random uncertainty due to the limited exposure time stems from the occurrence of large scale eddies and hence is large for low flow velocities and short exposure time as can be observed from Table 6.7. It further depends on the depth of observation. For observations near the riverbed more exposure time is required to arrive at the same accuracy as for locations higher up in the vertical. The table clearly indicates that for low flow velocities very large exposure times are required to avoid large errors. Therefore, the number of revolutions rather than a specific exposure time has to be specified for such circumstances.

**Random uncertainty due to limited number of points in the vertical  $X'_p$**

A large number of tests on irregular velocity profiles have been executed to arrive at the random uncertainty caused by observing the velocity vertical at one or a limited number of points as presented in Table 6.8. The table can easily be established for a particular site by observing the vertical at a great number of points and compare the average velocity thus obtained with the result from the one-point, two or three-point method.

Method of measurement	Uncertainties (%)
Velocity distribution	1
5 points	5
2 points	7
1 point	15

Table 6.8: Random uncertainty as a function of number of points in the vertical

**Random uncertainty in current meter rating  $X'_c$**

Uncertainties in the rating of current meters have a random and a systematic part. The random part can easily be obtained from regression analysis by considering the distribution of the rated points about the line of best fit. The systematic part is determined by the quality of the rating tank and the

manner in which the rating tank conditions resemble reality (being towed in stagnant water or being kept steady in a turbulent flow is not the same!!)

The random error part in the current meter rating is presented in Table 6.9. The data is based on experiments performed in several rating tanks. A distinction is made between individual rating and group rating.

Velocity (m/s)	Uncertainties (%)	
	Individual rating	Group or standard rating
0.03	20	20
0.10	5	10
0.15	2.5	5
0.25	2	4
0.50	1	3
> 0.50	1	2

Table 6.9: Random uncertainty in current meter rating,  $X'_c$

**Systematic uncertainty in width  $X''_b$ , depth  $X''_d$  and current meter rating  $X''_c$**

Variable	Term	Uncertainty (%)
Width	$X''_b$	0.5
Depth	$X''_d$	0.5
Current meter rating	$X''_c$	1.0

Table 6.10: Systematic uncertainty in width  $X''_b$ , depth  $X''_d$  and current meter rating  $X''_c$

Typical order of magnitude values for systematic uncertainties in the measurement of the width and depth and in current meter rating caused by the rating tank characteristics and the method of calibration are presented in Table 6.10.

**Application**

To illustrate the use of the error analysis a few examples are worked out in the following.

**Example 6.3**

Conditions: River discharge Q = 120 m<sup>3</sup>/s  
 Number of verticals = 20  
 Average velocity = 0.60 m/s  
 Method used = 1-point method (0.6D), 60 seconds exposure

Computation of error:

- $X'_n = 5\%$  (Table 6.5)
- $X'_b = 0.3\%$  (Table 6.6)
- $X'_d = 2\%$  (Table 6.6)
- $X'_e = 6\%$  (Table 6.7)
- $X'_p = 15\%$  (Table 6.8)
- $X'_c = 1\%$  (Table 6.9, individual rating)
- $X''_b = 0.5\%$  (Table 6.10)
- $X''_d = 0.5\%$  (Table 6.10)
- $X''_c = 1\%$  (Table 6.10)

With (6.14) the random error becomes:

$$X'_Q = [5^2 + 1/20(0.3^2 + 2^2 + 6^2 + 15^2 + 1^2)]^{1/2} = [25 + 266/20]^{1/2} = 6.2\%$$

From (6.15) the systematic error amounts:

$$X''_Q = [0.5^2 + 0.5^2 + 1^2]^{1/2} = 1.2\%$$

Finally, using (6.16) the overall uncertainty in the discharge becomes:

$$X_Q = [6.2^2 + 1.2^2]^{1/2} = 6.3\%$$

Hence the discharge is  $Q = 120 \text{ m}^3/\text{s} \pm 6.3\%$

In official documents according to ISO standards random and systematic uncertainties have to be specified separately; so the statement becomes:

Discharge =  $120 \text{ m}^3/\text{s} \pm 6.3\%$ , random uncertainty =  $\pm 6.2\%$ , systematic uncertainty =  $\pm 1.2\%$

Note that the true discharge is likely to lie between 112.4 and 127.6  $\text{m}^3/\text{s}$ , Hence there are 3 significant digits. So it makes **no sense** to present the discharge in **this case** with 1 or more decimals, see also Volume 2, Design Manual, Sampling Principles.

#### Example 6.4

Conditions: similar to EXAMPLE 6.3 but instead of using a 1-point method, the 0.2D&0.8D, i.e the 2-point method is used in the verticals.

It is easily observed that the use of the 2-point method only changes the uncertainty due to the number of points in the vertical  $X'_p$ . For the 2-point method one gets from Table 6.8:  $X'_p = 7\%$ . The random uncertainty then becomes

$$X'_Q = [5^2 + 1/20(0.3^2 + 2^2 + 6^2 + 7^2 + 1^2)]^{1/2} = [25 + 90/20]^{1/2} = 5.4\%, \text{ instead of } 6.2\% \text{ for the 1-point method.}$$

The overall uncertainty now reads:  $X_Q = [5.4^2 + 1.2^2]^{1/2} = 5.5\%$ , which is only a marginal improvement compared to the 6.3% before.

#### Example 6.5

Conditions: similar to EXAMPLE 6.3, but the velocity is now observed at 10 verticals only.

The change in the number of verticals affects only the random part of the uncertainty. From (6.14) and Table 6.5 one obtains for  $X'_n = 9\%$ . The other effect of this change is that the denominator (n) in (6.14) also changes. The random uncertainty then becomes

$$X'_Q = [9^2 + 1/10(0.3^2 + 2^2 + 6^2 + 15^2 + 1^2)]^{1/2} = [81 + 266/10]^{1/2} = 10.4\%, \text{ instead of } 6.2\% \text{ for sampling at } 20 \text{ verticals.}$$

The overall uncertainty now reads:  $X_Q = [10.4^2 + 1.2^2]^{1/2} = 10.5\%$ , which is **considerably worse** than in the two examples before.

The results from the examples are summarised and extended in Table 6.11.

Number of verticals	Random uncertainty in discharge $X'_Q$		Overall uncertainty in discharge $X_Q$	
	1-point	2-points	1-point	2-points
10	10.4	9.5	10.5	9.6
20	6.2	5.4	6.3	5.6
30	4.2	3.5	4.4	3.7
40	2.6	2.5	2.9	2.8

Table 6.11: Effect of number of verticals and number of points in the vertical on uncertainty in Q

From the theory and the examples it follows that:

- The most important factor to keep the uncertainty in Q low is to measure the velocity in a sufficient number of verticals ( $\geq 20$ )
- The reduction in the uncertainty in Q from measuring at two points rather than in one point is marginal.

- The systematic uncertainty plays only a marginal role in the overall uncertainty. (Note however the remark on the systematic uncertainty in the current meter rating: being towed in stagnant water or being kept steady in a turbulent flow is not the same!!)
- For low flow velocities short exposure time is an important source of error.

ISO further mentions that the error in the discharge can be reduced considerably by using knowledge of the continuous profile (an echogram) when determining the discharge, instead of using only the depth in the verticals where the flow velocity is observed!!

Reference is also made to Chapter 7 of Volume 4, Reference Manual for a summary of the tests carried out for ISO/TR7178-1983.

#### **6.4.13 MINIMISING ERRORS IN CURRENT METER DISCHARGE MEASUREMENTS**

In order to avoid and minimise errors and the amount of uncertainty the following is required:

1. A good understanding of river channel hydraulics and flow measurement instrumentation;
2. Good site selection and preparation;
3. Except in special circumstances always abide by the laid down standards and procedures and treat these as the minimum requirement;
4. Regular checks and re-calibration of equipment;
5. Check the results, when possible make comparisons with readings from other sites or other measurements taken at the same site;
6. At important routine sites, instruments and even observers should be rotated to avoid the introduction of a bias into the historic data set.

#### **6.4.14 ELECTROMAGNETIC CURRENT METER**

The electromagnetic current meter operates on the basis of Faraday's Law of induction whereby a conductor moving through a magnetic field creates an electromotive force (see Figure 6.41).

The coil that generates the electromagnetic field is located inside the body of the meter. On most basic electromagnetic current meters there are two electrodes on the body of the meter which sense the electric potential generated by the moving water. Other instruments e.g. the bi-directional meter, have four electrodes.

The electromagnetic current meter like the conventional rotating element current meter only samples point velocity. However, it has the advantage that it measures velocity directly, has no moving mechanical parts, can measure very low velocities and can operate in very high sediment concentrations and in weedy conditions. Electromagnetic current meters are susceptible to electrical interference effects, which may not be immediately obvious to the user. Their use very close to high-tension power cables should be avoided.

A specification for a two directional i.e. measuring flow velocity in the X - Y directions has been prepared as part of the moving boat method package and is referred to in Chapter 7. It is used in conjunction with ADCP, see Section 6.5. ADCP equipment have a dead zone in the top layer due to immersion and blanking of the transducers, i.e. the active area starts at some distance in front of the sensor-head. To enhance the data return and to compensate for dead zone losses, especially over shoals, the electromagnetic current meter could be used to collect velocity data in the top layer.



Figure 6.41:  
*Electromagnetic current meter*

## 6.5 ACOUSTIC DOPPLER CURRENT PROFILER (ADCP)

### 6.5.1 INTRODUCTION

The Acoustic Doppler Current Profiler (ADCP) is a device for measuring current velocity and direction, throughout the water column, in an efficient and non-intrusive manner. It can produce an instantaneous velocity profile down through the water column while only disturbing the top few decimetres. The instrument is based on the Doppler effect of sound waves scattered on particles suspended in the water.

The instrument was originally developed for use in the study of ocean currents - tracking them and producing velocity profiles - and other oceanographic work. It has since been developed for use in estuaries and rivers. It can also be used to measure flows in tidal rivers and, to some extent, monitor sediment flux. An ADCP can be mounted on a boat or a flotation collar or a raft and propelled across a river. The route taken does not need to be straight or perpendicular to the bank. The instrument collects measurements of velocity, depth, signal intensity and boat movement as it goes.

There are now several ADCP systems on the market. The technical detail and experiences highlighted in this section of the manual are based the RDI Workhorse Rio Grande and the SonTek ADP. Of those two, the Rio Grande features the widest range of capabilities for use on rivers. In Orissa both have been successfully tested for moving boat discharge measurement. CWC operates SonTek ADP 1000 ADCPs.



Figure 6.42(a):  
Broad-Band Acoustic Doppler Current  
Profiler

(Source: RDI)

Physically, an ADCP is a cylinder with a transducer head on the end (see Figures 6.42 a and b). The transducer head on the most widely used systems contains three or four acoustic transducers with their faces angled at  $20^\circ$  (RDI) or  $25^\circ$  (SonTek) from the vertical and  $90^\circ$  or  $120^\circ$  to each other. The cylinder houses a compass, tilt sensors, a data processing and storage unit and optionally, a battery pack. The battery pack is not necessary if a suitable external power source can be provided. Smaller instruments are currently under development. Recent developments resulted in specialised instruments, several for horizontal use and another with small cell size (centimetre) for application in very shallow ( $< 1$  metre depth) water.



Figure 6.42(b):  
View on SonTek APD unit

## 6.5.2 BASIC PRINCIPLES OF DOPPLER VELOCITY METERS

The reflection of sound waves from a particle, which is moving within a fluid, causes a change in frequency to the reflected sound wave. The difference in frequency between the transmitted and reflected sound wave is known as the **Doppler shift**. The ultrasonic Doppler flow measurement technology is based on this phenomenon.



Sound consists of pressure waves in air, water or solids. Sound wave crests and troughs consist of bands of high and low pressure. The **wavelength** is the distance between successive waves i.e. between two successive crests or troughs. The **speed-of-sound** is the speed at which waves propagate, or move by. The **frequency** is the number of waves that pass by per unit of time. The highlighted quantities are related by: speed-of-sound = frequency x wavelength.

### ***The Doppler effect***

The Doppler effect is a change in the observed sound pitch that results from relative motion i.e. a change in frequency by the motion of the source relative to a fixed point. A good example of this is the sound made by a train as it passes by a stationary person. The train's whistle has a higher pitch as the train approaches and a lower pitch as it moves away from the observer. This change in pitch (frequency) is directly proportional to how fast the train is moving. Therefore, if the pitch and by how much it changes is measured it is possible to estimate the speed of the train.

Another example of the Doppler effect refers to an observer who is standing next to water and is watching waves passing him. While standing still he sees ten waves pass by him in a given interval of time. If he starts walking towards the waves, more than ten waves will pass by him in the same interval. Thus the wave frequency appears to be higher. Conversely, if he walks in the opposite direction, fewer than ten waves will pass him in the same time interval and the frequency appears to be lower.

In terms of sound the Doppler shift is the difference between the frequency the observer hears when standing still and what he hears when he moves. The equation for the Doppler shift in such a situation is:

$$f_d = f_s \frac{v}{c} \quad (6.17)$$

where:  $f_d$  = the Doppler frequency shift  
 $f_s$  = the frequency of sound when everything is still  
 $v$  = the relative velocity between the sound source and the sound receiver  
 (the speed at which you are walking towards the sound in m/s)  
 $c$  = the speed of sound in m/s

### ***Notes:***

- If the observer walks faster, the Doppler shift increases;
- If the observer walks away from the sound, the Doppler shift is negative;
- If the frequency of sound increases the Doppler shift increases;
- If the speed-of-sound increases, the Doppler shift decreases.

### ***Doppler velocity meters***

The Doppler flow meter uses the Doppler shift principle to measure velocity in flowing water. The sensor transmits a high frequency (hundreds of kHz) ultra-sound wave into the water. This sound wave is reflected back towards the sensor by suspended particles, plankton or air bubbles. Very clean water can prove to be a difficult medium in which to use the Doppler technique. However, most, but not all, open channels should have sufficient suspended particles to obtain satisfactory reflected signals. The velocity sensor then measures the difference in frequency and this is converted into velocity by means of a processor built into the system.

When the sound reflectors (particles) move towards the sensor due to the velocity of flow, the sound heard by the reflectors is Doppler shifted to a higher frequency. The amount of this shift is proportional to the relative velocity between the sensor and the reflector. Part of this Doppler shifted sound reflects backwards or is “backscattered” to the sensor. The backscattered sound appears to the sensor as if the reflectors in the water were the sound source. Therefore the sensor hears the sound Doppler shifted a second time. Since the Doppler flow meter sensor both transmits and receives sound, the Doppler shift is doubled and the relationship becomes

$$f_d = 2f_s \frac{v}{c} \quad (6.18)$$

The Doppler shift only exists when sound sources and receivers move closer to or further from one another. If both move relative to a known datum but stay at a fixed distance relative to each other then there is no Doppler shift, i.e. the Doppler shift is 0. Also, if the receiver moves perpendicular to the sound source there will be no Doppler shift. Mathematically this means that the Doppler shift results from the velocity component in the direction of the line between the sensor and the reflector. Therefore the equation becomes

$$f_d = 2f_s \frac{v}{c} \cos \theta \quad (6.19)$$

where:  $\theta$  = angle between the particle (reflector) line of motion i.e. flow path and the direction of the acoustic (sound) beam.

### 6.5.3 ADCP FUNCTIONING AND COMPONENTS



Figure 6.43(a):  
Acoustic signals for the ADCP

(Source: RDI)



Figure 6.43(b):  
ADCP and boat

An ADCP uses the Doppler effect to measure the relative velocities between itself and suspended particles in the water column.

The ADCP applies the same method to measure its velocity relative to the bottom or riverbed. This measurement is known as bottom tracking. The bottom tracking acquires the velocity of the boat with respect to the bottom (river bed) in x and y direction. The x and y direction are ADCP referenced. If a compass is used, the velocity of the boat can be converted to east and north referenced boat velocities.

Each of the ADCP transducers emits a pulse of sound (a ping) into the water column. Suspended particles in the column reflect some of the sound back. The ADCP measures the Doppler shift of the reflected sound and uses this to calculate the relative velocity of the particles to itself. **The velocity of the particles is assumed to be equal to the velocity of the water current.**

The ADCP divides the water column into horizontal layers (cells). The thickness of the layers is adjustable, the maximum and minimum thickness are brand and model dependent. Typical ranges are 0.1 and 8 m (600 kHz RDI Workhorse) and 0.25 to 5 m (1000 kHz SonTek ADP). It is possible for the ADCP to estimate the x, y and z direction velocity components from the data obtained from 3 beams. The fourth beam, which is implemented on some models, is redundant. In case one of the four beams fails, still the velocities in x, y and z direction can be calculated. If all four beams deliver good data, the data of the fourth beam can be used to calculate an error velocity. The error velocity is a useful quality indicator for the delivered x, y, and z velocities. When ADCP measurements are executed close to a feature like a steep bank, vertical rock, sluice wall or similar, the data of the fourth beam - the one that radiates the feature - could be discarded. The remaining three undisturbed beams could be used to calculate the water velocity in each cell and the boat velocity with respect to bottom. Under such conditions, the three-beam ADCP is likely to produce distorted data.

The average velocity of each cell is calculated to produce a velocity profile (of the stack of cells or layers) of the water column. Velocity profiles, which were collected while traversing the channel, are subsequently processed by supporting software to estimate the total discharge of that channel.

The operator can adjust a multitude of parameters when setting up the ADCP for a deployment. Details of these parameters can be found in the manuals pertaining to the specific model of instrument. These manuals should be thoroughly understood by the ADCP operators and the data processing staff. Below some of the set-up parameters (cell size, ping rate, averaging interval) are discussed in general terms. The smaller the cell size, the finer the spatial detail in the profile, i.e. the more layers can be sampled. Further, when the cells are small, the ADCP can sample in shallower water. This can be easily understood when one imagines what would happen if the cell size were set to 5 m in 4 meters of water depth. In case of 0.25 m cells still many cells could be sampled in the very same water depth. However, the smaller a cell is the larger the single ping standard deviation will be.

The manufacturers specify the systematic velocity error, as introduced by the sensor, as less than 1 cm/s. However, the single ping velocity error can be in the order of 1 m/s. In normal operation the ADCP is programmed to execute a number of pings and report the averaged results thereof. In this context a ping is a measurement with a single sound burst from which a set of velocity data ( $V_x$ ,  $V_y$ ,  $V_{up}$ ) can be derived. In rivers, the execution and processing of a single ping is a matter of milliseconds, in deep ocean water a single ping may take a few seconds.

The standard deviation of the single ping velocity results is a fundamental instrument property, which is, roughly speaking, primarily dependent upon the noise threshold of the acoustic transducers with associated electronics and the number of sound waves that is available for the measurement. The higher the transmitted frequency and the larger the cell the smaller the single ping standard deviation becomes. The single ping velocity errors have a Gaussian distribution and as a result, the averaged velocity values will have a reduced standard deviation.

The table below shows the single ping standard deviation as reported by the M/s SonTek and M/s RDI. The RDI Workhorse Rio Grande can be operated in several modes. Mode 1 is very robust and can be used in most of the applications; it has the largest operational depth range. Modes 5 and 8 are intended for shallow water. M/s RDI reports that the maximum range should be less than 7 m. For that depth the maximum velocity should be less than 1 m/s. For operation in 4 m depth, the maximum velocity should be less than 2 m/s. In mode 5 the velocity shear and turbulence should be very low, in mode 8 there is no limitation in this respect.

manufacturer	frequency	mode	single ping st dev in cm/s
SonTek 3D ADP	1000 kHz	n/a	94
RDI Rio Grande	600 kHz	1	27
RDI Rio Grande	600 kHz	5	0.3
RDI Rio Grande	600 kHz	8	3.3

Table 6.1: Single ping velocity standard deviation for cell size of 0.25 m.

$$v_{sp} = 235 / (f z) \quad (6.19)$$

where:  $v_{sp}$  = the single ping velocity standard deviation in m/s

$f$  = the acoustic frequency in kHz and

$z$  = the size of the depth cell in m.

The value of  $v_{sp}$  halves when the cell size is doubled, however, when the readings of two adjacent cells are combined to a new value (also doubling the cell size) the standard deviation of the result decreases with the square root of 2 (1.4) only. From this it can be concluded that measuring with double cell size results in a smaller velocity standard deviation than is obtained by combining the data of two adjacent cells to get the same effective cell size. It should be noted that for other ADCP models the velocity standard deviation could show a different function of the cell size.

The standard deviation pertaining to averaged velocity values is estimated by:

$$V_{asd} = v_{sp} / N \quad (6.20)$$

where N is the number of pings available to calculate the average velocity.

The ping rate should be set at the highest value to acquire as many pings as possible for the averaging. The maximum ping rate for the SonTek ADP is 12 pings per second.

### **Components of the ADCP**

A typical ADCP set-up comprises 3 main units:

1. the ADCP
2. a laptop PC with the ADCP data processing software installed for control of the ADCP
3. a car battery and power adapter for the laptop PC

The ADCP can be used in two ways:

1. The ADCP can be set to record in stand-alone (Self Contained) mode, sent off to record the data and the collected data is downloaded to the PC later.
2. The second way is in real-time. The ADCP stays connected throughout the gauging process and the data is processed and displayed on the computer screen as it is recorded. This is the normal way for river discharge profiling from a moving boat.

The 2<sup>nd</sup> way is preferred since the 1<sup>st</sup> way does not provide any immediate feedback while the measurements are being taken. An external power supply is required on the boat in the 2<sup>nd</sup> case.

A typical ADCP flow measurement output showing the velocity distribution across the measuring section and the estimated discharge is shown in Figure 6.44.

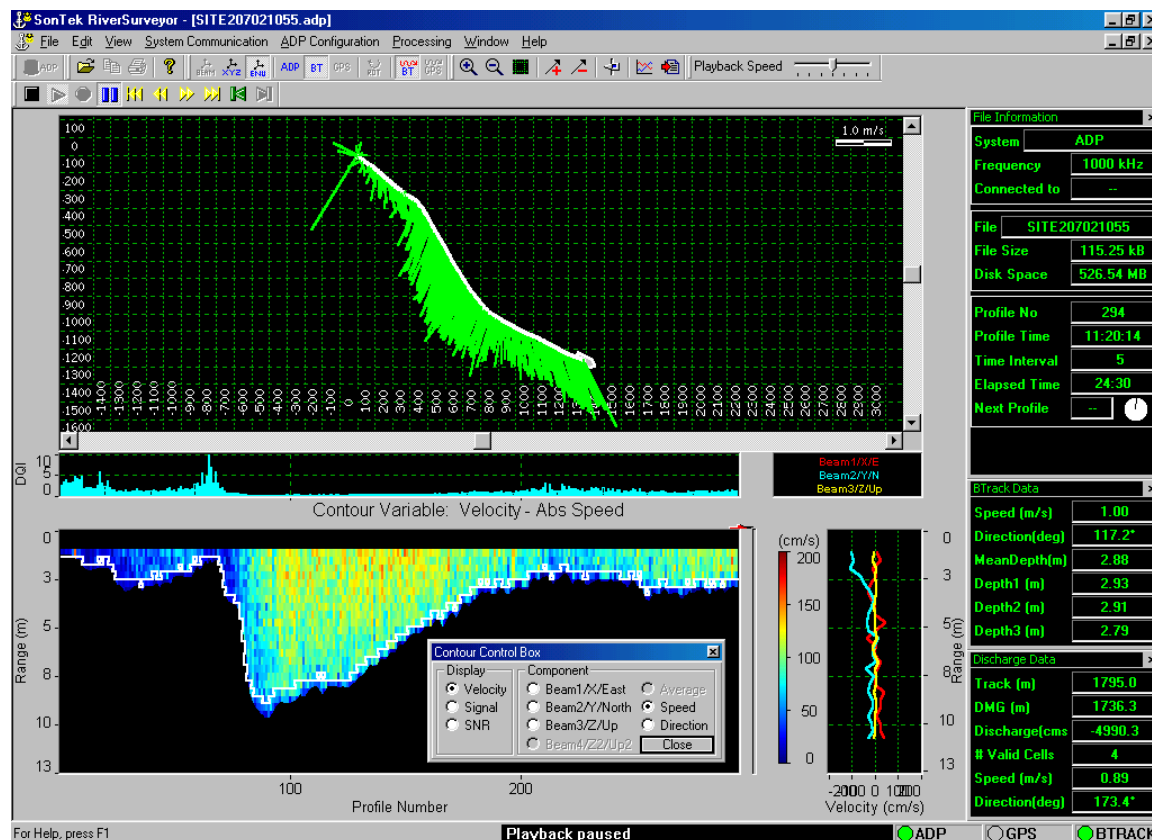

Figure 6.44: Example of River Surveyor Screen

### 6.5.4 PRACTICAL USE OF THE ADCP

In this sub-section following practicalities about the ADCP will be discussed:

- Deployment methods
- Practical considerations for use of the ADCP
- Overall performance of the ADCP

#### Deployment Methods

To produce a discharge estimate the ADCP has to be taken across (traversing) a river once with its transducers submerged to a known constant depth. Usually it is more convenient to cross the river from the one bank to the other and back again to end on the same bank as it started effectively executing two traverses. This should be executed at least three times. An average of the (3 x 2) results can then be taken. The discharge figures of these individual traverses should be compared with each other. Traverses showing large deviations should be neglected (not deleted). The measurements should continue till at least four discharge figures deviate by less than 5% from the average value. It is recommended that a number of traverses is made to see if, in steady flow conditions, repeatability occurs. In unsteady flow conditions executing multiple traverses provides an opportunity to monitor changes in discharge.

The most common way of using the ADCP is to fix it to a boat so that it can be vertically adjusted, (see Figure 6.45(b)). The boat fixings should be such as to allow the transducers to be fixed at different depths relative to the water surface. Also, they should allow the easy installation and fixing of the ADCP to the boat i.e. the ADCP should not be permanently fixed in the boat. Another way is to mount it in a flotation collar, which ensures that the transducers remain submerged to a constant depth. The flotation collar containing the instrument can then be towed across the river on a cableway or the end of a rope, pushed by a boat or even driven by a remote control motor. For the larger rivers the boat mounting method is recommended.

Some models of ADCP support autonomous (self-recording) operation. A useful advantage of the autonomous operation is that no communication with a controlling PC is required during traversing which implies, that after proper set-up the instrument can be towed from one bank to the other without the need for a communication cable. Also during heavy rain, when the use of a PC is risky, the autonomous mode is very practical. After execution of one or more traverses, the data can be retrieved for processing. The start and stop times should be duly annotated to allow connection of the discharge figures to actual events. The annotated times should be derived from the same clock as used for setting the clock of the ADCP. To support the autonomous mode, the ADCP has to be fitted with a PC-card for storage of the data.

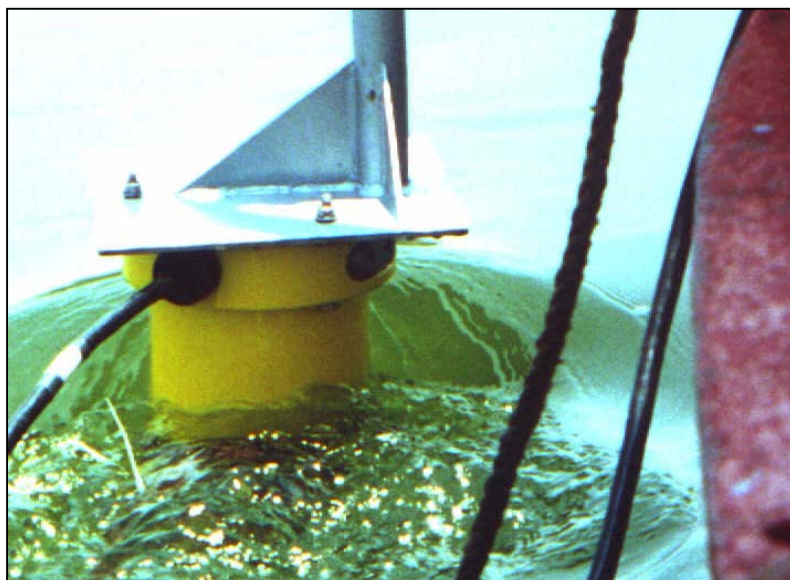

*Figure 6.45(a):  
ADP in operation*



*Figure 6.45(b):  
ADCP deployed from a boat*

---

**Practical Considerations**

1. The ADCP unit makes large demands on power while operational. A car battery and adapter for the laptop PC are necessary to run the laptop and the ADCP in real-time. Some ADCP models allow the use of internal battery packs. Although this avoids the need for external power, it increases operational cost and the risk of water ingress due to sloppy closing of the ADCP housing after installation of the battery pack.
2. The boat velocity is measured by the bottom tracking function, which makes use of the bottom (Doppler) reflection of the sound beams to obtain the boat velocity relative to the bottom. This is an accurate measurement provided that the bottom is stationary. However, at high flow velocities, thick blankets of bottom sediment may be mobilised resulting in bias on the bottom track measurement. Under such condition a (D)GPS system is required to obtain the velocity of the boat. This adds to the cost and increases complexity considerably. The DGPS provides the boat track relative to a north referenced coordinate system. The ADCP obtains water velocity with respect to the boat and referenced to magnetic north using the compass. The water velocity with respect to the ground is calculated subtracting the boat velocity from the measured water velocity (relative to the boat). This subtraction of two large values can only result in accurate flow data when the ADCP's compass is accurately calibrated and precisely lined up with true north. The importance of this can be appreciated when one considers the measurement of velocity in stagnant water e.g. of a reservoir. If the compass is not precisely lined up, the displayed water velocity will be proportional to the sine of the direction error multiplied by the boat's speed. At a boat speed of 1 m/s and a direction error of 5°, the velocity error would 9 cm/s.

When using DGPS to obtain boat velocity and position data, it is essential that the ADCP compass is calibrated thoroughly prior to its use. Further a non-magnetic boat should be used. If magnetic anomalies exist, e.g. due to metal structures or ship nearby, the magnetic compass method will fail. An accurate gyrocompass should be used then. This again increases cost and power demand. For normal ADCP measurements when bottom tracking is performing well a normal compass calibration would suffice.

3. The minimum depth of deployment is recommended not to be less than 1.0m for more than 5% of the cross-section. The depth of operation is not the actual depth but the distance from the ADCP transducers which should be mounted whenever conditions allow, at least 0.3 m below the surface or below the hull of the boat (whichever is the greater). However, if a moon pool / well is used it should be possible to mount the faces of the transducers just below the hull of the boat provided aeration does not occur underneath the hull. (Aeration blocks the passage of sound waves.) Mechanical vibrations may adversely affect the performance of the ADCP. A special case is the coupling of sound waves into the hull and back to the ADCP again. In that case the transmitted sound penetrates the boat's hull, rings around in the boat and is transmitted into the water again. The ADCP in receiving mode captures the sound which effectively corrupts the proper measurement of the upper cell(s). If this occurs, the not-measurable layer just below the ADCP increases beyond the standard blanking distance.
4. From a safety perspective, the average velocity in the measuring cross-section should not exceed 4 m/s. However, this will be governed to a certain extent by the boat engine size and the skill of the boat operator.
5. The diagram Figure 6.45(c) shows a typical outboard installation of an ADCP. The instrument is supported by a rod. While taking measurements, the rod is in vertical position to submerge the transducers whereas the rod is brought to horizontal position to enable sailing at high velocity, e.g. from one measuring station to the other. The vertical position of the rod is maintained by a guy wire. Care should be taken that the rod can swivel away in case the instrument hits an obstruction, the guy wire may be allowed to slip free then.

The ADCP can only function properly when it is in the water; therefore the instrument should be kept submerged. To cover as much of the water column as feasible, the ADCP should be fixed at a minimum submersion depth close to the water surface while avoiding trapping of bubbles or an air gap below the transducers.

6. The acoustic transducers were designed to have narrow beams; however, unavoidably the transducers also have side lobes, which transmit energy in unwanted directions. Most of the side lobes are entirely harmless; however, the side lobes that are directed at the bottom have a major impact on the capabilities of the ADCP. This can be understood as follows. Although the side lobes have much less acoustic efficiency as the main lobe, they receive a strong signal from the bottom; after all, the bottom is a very good reflector in comparison to the tiny suspended scatterers. As a result, the bottom reflection overwhelms the signals reflected of normal scatterers effectively corrupting the velocity measurement. The **distance** along the slanted beams to which the ADCP can measure velocity equals the water depth below the sensor. The **depth** to which the ADCP can measure water velocity depends upon the beam angle of the main lobe. For the SonTek ADP this angle is  $25^\circ$ , the related maximum measurement depth is at  $\text{COS}(25^\circ) \times \text{depth}$  below the transducer, which is about 90% of the distance from the ADCP to the bottom. The blind zone is about 10% of the depth below the transducer. RDI ADCPs have an angle of  $30^\circ$  or  $20^\circ$ , which results in blind zones of 14% and 6% respectively.

The valid range is calculated from  $0.9 \times (\text{depth below sensor} - \text{depth below surface}) - \text{blanking distance}$ . Only entire cells should be used, bottom cells that are (partly) contaminated by side lobe - bottom reflection should be discarded.

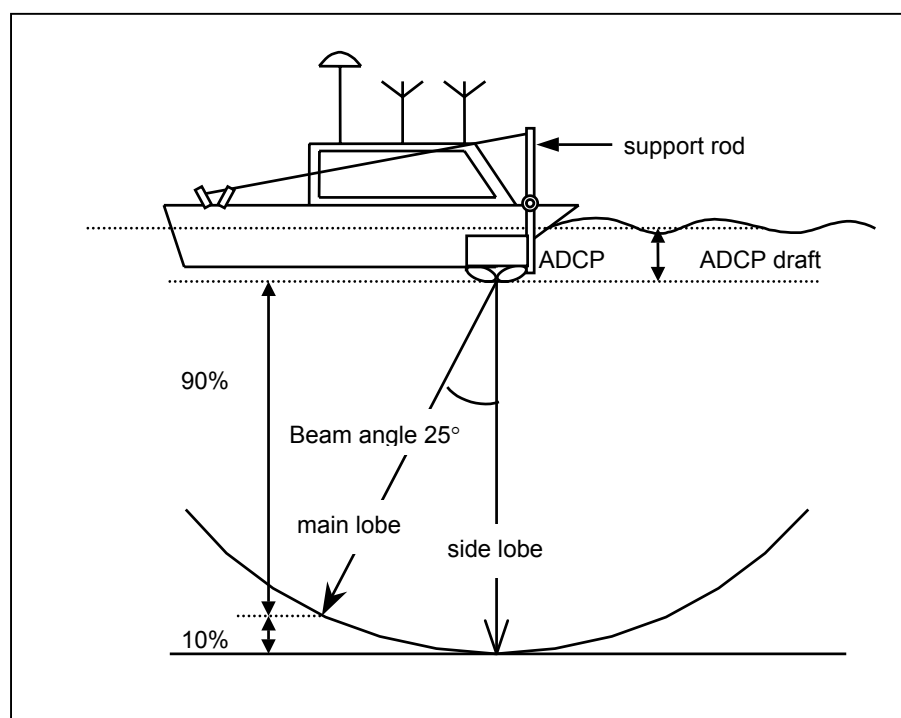

Figure 6.45(c): Relationship between transducer beam angle and thickness of the contaminated layer

7. It is not possible for the ADCP to sample the full vertical velocity profile. There is also an unmeasured band close to the surface see, Figure 6.45(d). This unmeasured portion at the surface consists of the distance between the surface and the faces of the acoustic transducers (the draft of the ADCP) and a dead band which is the blanking distance of the acoustic transducer, e.g. 0.5m. The blanking distance is related to the length of the transmitted acoustic pulse and the switch-over from transmission mode to receive mode of the transducers. Therefore, if the transducers are fixed at e.g. 0.3 m below the surface no measurement of velocity will be obtained in the upper 0.8m of the water column, i.e. in this example the top of the first cell is at 0.8 m below the surface. The unmeasured upper and lower portions of the verticals are defined automatically by extrapolation by the ADCP's software. This extrapolation is undertaken using assumptions based on the classical form of the velocity profile, either using a power law or a



straight-line method. Alternatively, an electromagnetic current meter can measure the velocity in the upper portion. The values in the example above depend upon the type of ADCP.

The diagram below gives an impression of the measured and unmeasured sections of the cross section. For rivers where shoals have to be crossed in measuring mode, it is recommended to set the minimum cell size such that over the shoals of at least two cells valid data is obtained.

Very close to the banks the velocity data may also be corrupted, depending upon the type of ADCP, the beam configuration and the slope of the banks.

8. The instrument does not perform well in aerated water. Therefore, the transducers have to be immersed at sufficient depth to avoid air entrapment caused by turbulence on the water surface and/or the movement of the boat. Conversely, particularly in shallower rivers the transducers should not be immersed at too great a depth otherwise a significant portion of the vertical profile may not be sampled. Care should be taken to ensure that the transducers are at some distance from the boat's hull to avoid interference by sound reflected from the hull.

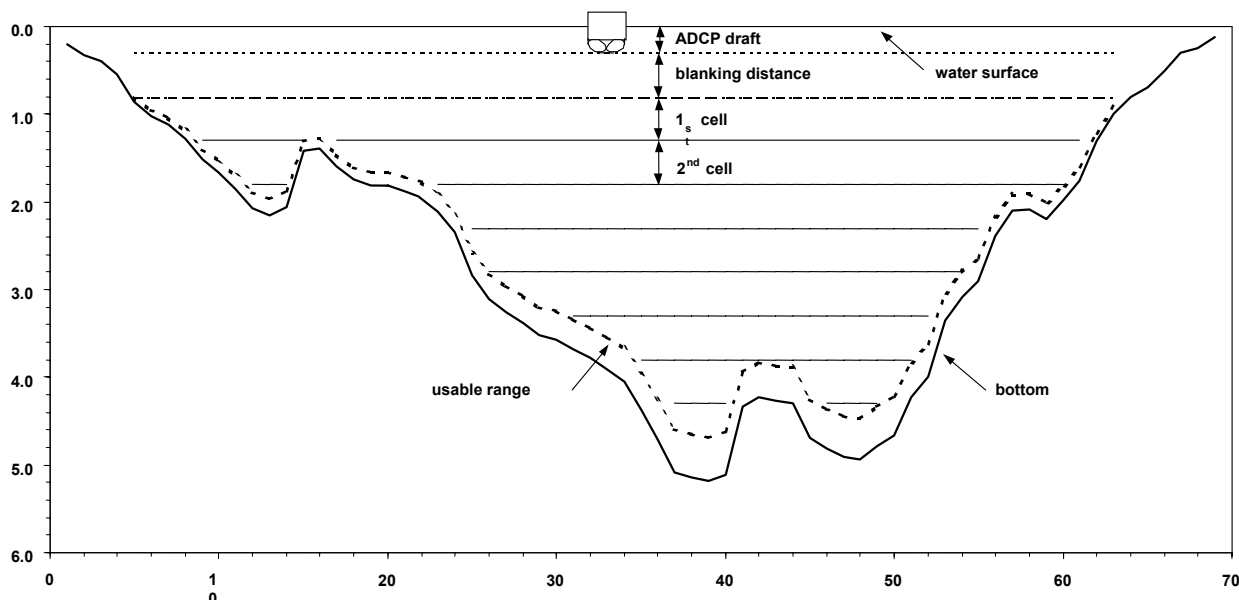

Figure 6.45(d): Effects of depth, draft and blanking on profile

9. It is recommended that a special lightweight (alloy) frame be built for the ADCP. This frame should serve three purposes:
  - make carrying easier
  - protect the ADCP
  - provide a means of fixing the ADCP to any/most boats

The frame should be supported by a guy wire (as shown in the sketch above showing the ADCP mounted on a small boat) to prevent the ADCP leaning back while sailing at some speed. For high speed sailing it is recommended to swivel the frame so as to bring the ADCP above the water surface.

It is recommended that a cover is fabricated to fix over the bottom of the frame to protect the transducer faces when the ADCP is not being deployed.

During traversing while collecting data the movements of the boat should be smooth to avoid errors in the bottom tracking function. Preferably the boat should maintain a constant speed during the entire traverse. Sudden changes of course and accelerations / decelerations should be avoided. The reason for this is the performance of the ADP bottom tracking, which is also affected by the faulty readings of the tilt sensors when the boat changes speed or heading. The tilt sensors are referenced to the direction of the local vector of acceleration, which is the acceleration of gravity under stationary conditions. However, the reference vector tilts in case of horizontal acceleration e.g. when the boat changes speed and / or course.

10. The ADP bottom tracking is having difficulty with sloping bottom. If in a cross section such failure is observed, a slightly more up stream or down stream cross section may be tried for better data.

A specification for the ADCP is contained in 'Equipment Specification Surface Water', see also Chapter 7.

### ***Overall Performance of the ADCP***

Acoustic Doppler Current Profilers are relatively new hydrometric instruments. However, they have already been used successfully in small and large rivers such as the Great Lake system (on the Canada US border). River depths here vary between 4m and 20m and the average discharge is 5,000 m<sup>3</sup>/s. Extensive use of the ADCP has been made on Ganges and Brahmaputra rivers in Bangladesh, measuring discharges up to 100,000 m<sup>3</sup>/s (Delft Hydraulics et.al. 1996). Successful projects have also been completed on rivers such as the Mississippi and the Danube. The equipment has been found to be very good at spotting areas of recirculation and other anomalies in the flow regimes.

ADCPs are established instruments for hydrometry. The equipment is costly and requires a relatively high level of technical ability. Therefore, it is only recommended for use at larger, more important sites e.g. inter-State borders where more conventional methods are not viable, for research and for verification measurements at gauging sites.

### **6.5.5 COLLECTING DISCHARGE DATA WITH A SONTEK ADP**

The first step is to identify a proper cross section, which should be in a straight river section. The cross section should have uniform flow; heavy turbulence and boils are to be avoided. Actually the same selection criteria as applied for traditional discharge measurements should be applied. Some aspects need special attention to make best use of the ADCP's capabilities.

The cross section should have as smooth a bottom profile as possible without steep slopes and shoals. Steep slopes hamper the performance of the bottom tracking because at the slope each of the beams obtains entirely different depth readings, further the averaged depth value may not be representative. The water depth should be sufficient to cover at least a few depth layers (cells) but should stay well within the depth capabilities of the ADCP. The unmeasurable section on each of the banks should be as small as possible. The flow rate at the banks and in particular in the unmeasurable sections should be as low as possible.

The survey boat should traverse along the cross section in a smooth manner i.e. the speed and course should be kept steady during the data collection. Significant changes in speed (acceleration or deceleration), or sudden course changes jeopardise the bottom tracking, which renders velocity readings of the affected profiles virtually useless.

The ADP, being an acoustic instrument, needs information about the actual speed of sound. To estimate the speed of sound, the instrument is fitted with a temperature sensor. The salinity is to be entered manually, however, for use in non-tidal river sections and reservoirs the salinity would be 0. The use of the in-built temperature sensor should be enabled.

After transport and at the beginning and end of each measuring day, the compass should be calibrated using the software supported calibration procedure. The results should be annotated in the instrument's logbook. If deviations with previous calibrations are substantial, i.e. exceeding several degrees, whereas the boat, installation and other significant aspects were not changed, the cause should be investigated.

The choice of cell size (thickness of the measured layers) affects the measured section in the profile and the standard deviation of the velocity data. The smaller the cells, the larger the part of the vertical profile that can be measured and the shallower the water may be. However, the smaller the cells the larger the standard deviation becomes. For each cross section depth profile the optimum cell size should be assessed. The cell size should be chosen small enough to cover at least two valid cells over shoals (if they exist). Preferably, although difficult, a cross section with uniform depth is selected for discharge measurements.

Especially during periods of high discharge, the performance of the bottom tracking should be verified in particular to check if the bottom tracking performance is affected by moving bed. This is done by monitoring the apparent position of the boat as obtained from the bottom tracking while the boat remains anchored at some spots on the cross section where moving bed conditions are likely. The anchoring should be safe (high flow velocity) and stable, i.e. the anchor should hold properly. The anchor line should be at least 1.5 times the water depth preferably with some ends of chain between the anchor and the anchor line. The dragging of the anchor can be monitored visually with respect to points on the bank. An apparent upstream movement of the boat on the bottom tracking display is an indication of a moving bed condition. Moving bed can be very local, moving to another cross section may avoid the problem. The ADCP data file as collected during the bottom tracking test(s) should be retained and its name, time and other particulars duly annotated in the station logbook.

At the start of each transect the distance to the bank is to be estimated to define the unmeasured section of the stream. Further, some qualitative information about the observed flow pattern at the surface would further enhance the flow estimate in the unmeasured sections. It would be interesting to know if the section between boat and bank is covered by plants, rock; if reverse flow is observed or large eddies and similar. The same observations are to be made and annotated at the end of the transect.

The boat velocity with respect to the bottom should be slow in order to take as much data as possible. Averaging a large number of pings would reduce the standard deviation of the velocity results and further it would reduce the effect of turbulence. As a rule of thumb, traversing the cross section should take at least a few minutes. On very small streams this may be difficult to achieve. On large rivers the velocity, relative to the bottom, should be chosen equal to the average water velocity or smaller, given the width of such rivers, traversing would take much longer than a few minutes.

All the observations and actions should be duly annotated in the cross section logbook. The same applies to the observations while traversing the cross section. These may have to do with the measurements (bottom tracking failure due to steep slopes (too deep, jerks) large signal intensities (sediment?), the boat (jerk, deviation of track to avoid collision with floating debris) but also with the river proper.

Provided that the traverses are started and ended at a conspicuous point on each of the banks, an upstream drift in displayed end position could be an indication of a moving bed condition. However, many other reasons can result in similar drift. In any case, if consistent upstream drift is detected, in both left-to-right and reverse traverses, the data should be carefully assessed for possible moving bed conditions. Another indicator of possible moving bed is the measurement of high signal intensities (due to high sediment concentrations), in particular close to the bottom.

---

### 6.5.6 PROCESSING OF SONTEK ADP DATA

The top and bottom layers were extrapolated by the River Surveyor default method (power fit distribution with an exponent of 0.167 using the entire profile data). The distances-to-bank at begin and end of the cross section as entered during the measurements were used to extrapolate to the banks. Cell size was 0.25 m, transducer depth 0.15 m and blanking distance 0.5 m. The applied averaging interval was 5 seconds.

It is of great importance to observe good validation practices. One of the key aspects is that the entire processing is traceable, i.e. starting with the raw data and using the annotations / remarks pertaining to a previous processing run on the same data, it should be possible to redo the processing and arrive at the same results.

Both RDI and SonTek include a software tool for processing of the ADCP data, viz. WinRiver and RiverSurveyor respectively. Although these tools save some of the settings during processing, they do not keep track of the entire processing session. One of the causes is that part of the processing may be done with other tools like Excel or MatLab. Below the use of RiverSurveyor is addressed. The details about RiverSurveyor have to be learned from the accompanying manual.

As discussed above, the ADCP cannot measure the entire complete cross section; mainly the edges (top, bottom, banks) are beyond reach. Hence, the contribution of the edges has to be estimated as good as possible. Next the RiverSurveyor settings to estimate the discharge of the unmeasured sections are discussed.

#### ***Bottom layer***

RiverSurveyor supports two methods to estimate the velocity in the lower 10% (cannot be measured due to side lobe interference) of the profile. One method attributes the velocity of the lowest valid cell(s) to the unmeasured bottom layer. The second method applies a power-fit through the collected profile data and extrapolates this fit to the bottom. For calculation of river discharge, the power-fit method is to be preferred. The default exponent for the fit is 0.1667; the exponent may be changed but always with great care and only after checking the performance. Normally the entire profile should be used.

#### ***Top layer***

The average velocity of the top layer may be estimated with the same methods as described under Bottom layer. Also in this case the power-fit method is to be preferred as it uses data of multiple cells which would reduce random error. However, under certain conditions, like stratified flow, the power-fit method might perform badly.

#### ***Banks***

The discharges at the start-bank and the end-bank can be individually estimated. Two methods are available, viz.:

1. entry of a user estimated discharge, e.g. measured by current meter  
The quality of the estimate is determined by the measurement and the extent to which the manual and ADCP measured areas are complimentary without overlap or gap.
2. calculated estimate based on distance to bank and velocity profile(s) measured next to the bank. Several fields have to be entered for a proper calculation.
  - In a canal the bank shape may be chosen as Vertical, in a river it is normally Slope.

- The distance to the bank should be entered according to the distance where proper data collection started should be entered.
- The profile to start / end the calculation should be chosen with some care; it should not be contaminated by bad bottom tracking or similar and it should have one or more valid depth cells.
- If needed, the results of several profiles in a row can be used to calculate average values for depth and velocities which are to be used to calculate the estimate of the unmeasured discharge of the start / end section.

It should be noted that the described estimation methodologies rely on the assumption that the flow velocity distribution over the profile (vertical) is not stratified. In river bends (it is not recommended to collect discharge data there), and over shoals this may not be the case, special attention is required then.

The speed-of-sound at the transducer faces should be known for the data processing. It is recommended to let the ADCP measure the water temperature at its sensor and use that value for automatic estimation of the speed-of-sound. The actually applied value should be checked.

## EXAMPLE

Summary data as reported by RiverSurveyor pertaining to a particular traverse is presented in the table below.

### Summary report

Measured Middle Portion Discharge	190.7 m <sup>3</sup> /s
Estimated Top Layer Discharge	58.3 m <sup>3</sup> /s
Estimated Bottom Layer Discharge	13.3 m <sup>3</sup> /s
Estimated Start Edge Discharge	0.9 m <sup>3</sup> /s
Estimated End Edge Discharge	1.8 m <sup>3</sup> /s
Total Discharge	264.9 m <sup>3</sup> /s
Measured Discharge as a % of Total	72.0 %
Measured Distance	176.9 m
Maximum Water Depth	6.74 m
Maximum Measured Depth-Averaged Velocity	1.40 m/s
Maximum Vessel Velocity	0.94 m/s

As reported, 72% of the discharge was measured and 28% was estimated by extrapolation to banks, bottom and surface. In the example, the top layer is by far the largest discharge contribution that could not be directly measured. The thickness of the top layer depends upon the depth of the instrument and the blanking range: both should be as small as feasible. The minimum cell size and blanking range are instrument specific, though.

Although discussed before, the discharge value as presented by RiverSurveyor might be contaminated due to bottom tracking failure. In case flow velocities during the traverse were high and substantial sediment transport was likely the results should be interpreted with caution and checked for the effects of moving bed conditions.

The collected data should be subjected to a validation procedure before being accepted for use. The validation procedure should assess the velocity measurements, the bottom tracking and the depth measurements. Related to the bottom tracking, the boat's velocity over the ground should be determined and checked for smooth speed and course. The acoustic intensity (back scatter signal) and its distribution over the vertical should be assessed for possible high sediment concentrations

near the bottom. In particular outliers in the bottom tracking data may occur, the effects thereof can be reduced by interpolation. The validation methodology should be traceable and properly recorded.

The RiverSurveyor results can be exported to discharge files; the latter have default extension DIS. The DIS files contain time series data of aggregated data like bottom tracking derived position relative to the starting point; depth averaged velocity; discharge values and similar data, all at a fixed time interval (the averaging interval) e.g. 5 seconds.

Based upon the sailed distance, as derived from the bottom tracking data, the boat speed over the ground can be calculated for each time interval. Knowing that the boat was sailing with a fairly constant speed (although relative to the water) certain outliers in the data can be identified by comparing the calculated speed of the boat against a maximum acceptable threshold value (e.g. 1.25 m/s, slightly larger than the estimated sailing speed). The actual threshold can be derived from the measured speed over the ground by analysing the timeseries discarding the apparent outliers. First all values that deviate by more than 95% of the average value should be removed and marked accordingly. Of the remaining boat velocity values the average and standard deviation should be calculated. Values that deviate by more than two times the standard deviation of the speed over the ground should be marked. The associated discharge values for the marked intervals should be replaced by interpolation from the last good value before the marked interval(s) up to the first good value after the marked interval(s). For both velocity and depth interpolated values should be inserted. The DIS data file can be imported in Excel spread sheet for processing. It is recommended to retain the original raw data file, the DIS file and the excel file. A record of the validation method, steps and manipulations should be prepared separately. The accuracy of the validation results can be further augmented by careful estimation of the flow in unmeasured bank sections and extrapolation method towards the bottom and surface.

This simple method mainly replaces data that are corrupted due to the before mentioned bottom tracking errors. The validation results for some test traverses are presented in the table below under the header marked "corrected". The percentage column expresses the deviation of individual (corrected) discharge figures with respect to the overall average of that same column. The discharge was not measured by classic current meter. Hence, no comparison could be made. Obviously the applied validation and correction method improves the consistency of the individual results. A prerequisite for this validation and correction method is a smooth sailing along the cross section, stable in speed and course: such method of sailing improves data quality anyway because the bottom tracking performs better.

The raw data file and the Overview of all cross sections.

file	raw		corrected	
	m <sup>3</sup> /s	%	m <sup>3</sup> /s	%
UKT0209211150	302.8	7.6	270.8	1.4
UKT0209211209	271.8	-3.4	267.4	0.1
UKT0209211218	361.2	28.4	265.7	-0.6
UKT0209211227	266.4	-5.3	262.5	-1.8
UKT0209211327	271.8	-3.4	265.9	-0.5
UKT0209211336	261.4	-7.1	276.2	3.4
UKT0209211343	246.7	-12.3	265.3	-0.7
UKT0209211535	285.4	1.4	263.5	-1.4
UKT0209211544	264.9	-5.9	267.3	0.0
<b>mean</b>	<b>281.4</b>		<b>267.2</b>	

### 6.5.7 ADCP - GLOSSARY OF TERMS

The following glossary contains terms, which are used frequently when referring to the ADCP.

Acoustic	Pertaining to sound.
ADCP	Acoustic Doppler Current Profiler. (manufacturer M/S RDI)
ADCP Depth	See Depth, Transducer.
ADP	Acoustic Doppler Profiler (same type of instrument as ADCP, different manufacturers: M/S SonTek and M/S NorTek).
Averaging interval	the period of time, in seconds, over which the ADP averages data to compute a mean velocity profile.
Bin	often used as equivalent for depth cell, layer of water. However, bins are also used to indicate the elements of the array of elements of the individual beams where data is collected. Bins are beam related and oblique whereas cells are layer related and in principle horizontal.
Blanking distance	the region in front of the transducers where no measurements can be made. This is measured as the vertical distance from the ADP transducers to the start of the first depth cell. The blanking region is required for the transducers and electronics to recover from the transmit pulse.
Bottom tracking	feature, which measures the ADCP's velocity relative to the bottom, also by the Doppler principle
Cage	supporting framework.
Carrying Assembly	deployment assembly, mounting assembly, framework constructed to support the ADCP during transportation and deployment.
Cell	equivalent to layer of water
Communication cable	cable connecting the ADCP to the deck box during initialisation and downloading.
Data Retrieval Modes	two different modes, self contained and real time, in which the ADCP can retrieve data.
Deploy	initialise the ADCP to collect data then propel the instrument across the section to record data. A deployment can last for several river traverses.
Deployment fixings	items attached to the ADCP and required for deployment e.g. cableway.
Deployment method	technique for propelling ADCP across river e.g. boat.
Deployment mode	mode, water mode, operating mode, profiling mode, defines the type and pattern of sound pulses emitted by the transducers and the way they are processed e.g. mode 5, mode 8.
Depth cell location	to calculate the location of the center of each depth cell, multiply the depth cell number (starting with 1 closest to the ADP) by the depth cell size and add the blanking distance. See "ADP Principles of Operation" for details regarding depth cell size and location.
Depth cell size	this defines the resolution of the velocity profile, in m. This is specified as the vertical distance from the ADP, and not the range along the path of the acoustic beams. See ADP Principles of Operation for details on the exact definition of ADP depth cells.
Depth, Transducer	the depth of the ADCP transducers below the water surface during deployment.
Doppler Effect/Shift	change in an observed sound frequency caused by the relative velocity between a sound source and an observer.

---

Download	retrieval of data from the ADCP using the ADCP computer.
Number of cells	the number of cells collected in each profile.
Operating mode	see Deployment Mode.
Pass	see traverse.
Ping	a single estimate of the water velocity profile. A ping consists of each transducer sending a short acoustic pulse, calculating the along-beam velocity profiles, and combining data from all beams (and the internal compass/tilt sensor if enabled) to compute the velocity profile.
Pinging rate	the number of pings per second, in Hz. This is normally determined by the propagation speed-of-sound, although the variable "Ping Interval" can be selected to achieve a slower pinging rate for certain applications.
Ping interval	the minimum time between sequential pings, in seconds. The default setting of 0.0 seconds causes the ADP to ping as rapidly as possible
Profile	in addition to its more general use, profile refers to the collection of a number of pings to produce a mean estimate of the water velocity at each depth cell. A profile includes velocity, standard deviation, and signal strength data.
Profiling mode	See Deployment Mode.
Profile time	the ADP records date and time from its internal clock with each profile. The recorded time represents the start of the averaging interval.
RDI	RDI Instruments, suppliers of ADCPs.
Real Time (Mode)	data retrieval mode in which the ADCP relays information to the operating computer as it gathers it. The ADCP and computer are connected throughout the deployment.
Receive Signal	reflected ultrasonic pulse received by a transducer.
Salinity	water salinity, in ppt. The value input by the user is for speed-of-sound calculations.
Self Contained (Mode)	data retrieval mode in which the ADCP stores the information it gathers. This data is then downloaded to the computer after deployment.
Speed-of-sound	speed-of-sound, at the transducer face, in m/s. This converts Doppler shift to water velocity. Speed-of-sound is either calculated from user-specified temperature and salinity, or from measured temperature and user-input salinity.
Temperature	water temperature, in °C. Either default temperature inputted by the user, or measured using an internal sensor. Mean and standard deviation of measured temperature are recorded with each profile. Temperature is used for speed-of-sound calculations.
Transducer	acoustic device for transforming one form of energy into another, in this case electronic energy into ultrasonic sound energy and back to electronic energy.
Transducer Depth	see Depth, Transducer.
Traverse	pass, one sweep across a river during an ADP deployment. In self contained mode a deployment can consist of any number of traverses. In real time mode a deployment consists of one traverse.
Water velocity	velocity relative to the ADCP instrument.

---



## 6.6 SLOPE - AREA METHOD

### 6.6.1 INTRODUCTION

The slope area method is based on open channel formulae like Manning's formula for estimating velocity using surface water slope and channel geometry.

The method has been used for the following discharge estimation applications:

1. at the time of determining gauge heights from a series of gauges;
2. for a peak flow that left marks on a series of gauges or where peak stages were recorded by a series of gauges;
3. for a peak flow that left high-water marks along the stream banks.

The method can be used with reasonable accuracy in open channels having stable boundaries bed and sides, in lined channels and in channels with relatively coarse material. It may also be used in alluvial channels, including channels with overbank flow or non-uniform channel cross-sections, but in these cases the method is subject to large uncertainties owing to the selection of the rugosity (roughness) coefficient, such as Manning's  $n$  or Chezy's  $C$ . The slope-area method is not normally recommended for use in very large channels, channels with very flat surface slopes and high sediment loads or channels having significant curvature.

The method has been used fairly widely in India to estimate peak discharges when it is not possible to make flow measurements using current meter gauging or float methods. At CWC sites three sets of gauge posts are usually installed. These gauge posts are normally located about 50 m apart, i.e. a total distance of 100 m. These gauges are read simultaneously at least before and after current meter gauging. The current meter gauged discharge is used along with the slope computed from the difference in water levels and channel geometry to estimate the Manning's  $n$  and Chezy's  $C$  values. As the distance over which the difference in level is being measured is short, the differences in level could be as low as or close to the uncertainties in the stage measurement. Therefore the uncertainties in the estimated discharge measurements could be high.

### 6.6.2 PRINCIPLES OF THE METHOD OF MEASUREMENT

A measuring reach is chosen for which the mean area of the stream or river cross-section is determined and the surface slope of the flowing water is then measured. The selection of a suitable measuring reach and other site selection criteria are discussed in Chapter 4. The mean velocity is then established by using known empirical formulae such as Manning or Chezy, which relate the velocity to the hydraulic mean depth, and the surface slope is corrected for the kinetic energy of the flowing water and the characteristics of the bed and material. The discharge is computed as the product of the mean velocity and the mean cross-sectional area.

The Manning equation was developed for conditions of uniform flow, in which the surface water slope and energy gradient are parallel to the stream bed, and the area, hydraulic radius and depth remain constant throughout the reach. It is assumed that it is also valid for non-uniform reaches, which are encountered in natural channels, if the water surface gradient is modified by the difference in velocity head between the cross-sections.

The mean velocity in an open channel can be estimated using the Manning formula, thus:

$$\bar{v} = \frac{1}{n} R^{2/3} S^{1/2} \quad (6.20)$$

where:  $\bar{v}$  = average velocity (m/s)  
 $R$  = hydraulic radius (m) =  $A/P$   
 $A$  = cross-sectional area  
 $P$  = wetted perimeter  
 $S$  = Slope of the energy line (see below)  
 $n$  = Manning's n (roughness coefficient)

Therefore, discharge can be derived from (6.20) and (6.1)

$$Q = A \times \bar{v} = \frac{1}{n} AR^{\frac{2}{3}} S^{\frac{1}{2}} \quad (6.21)$$

This can be expressed as:

$$Q = KS^{\frac{1}{2}} \quad (6.22)$$

where:  $K$  = the conveyance =  $\frac{1}{n} AR^{\frac{2}{3}}$

The total energy of flowing water per unit weight is the total head  $H$  in metres, which is the sum of the elevation above a datum, the pressure head and the velocity head.

$$H = z + Y + \frac{\alpha \bar{v}^2}{2g} \quad (6.23)$$

$$\text{or: } H = Z + \frac{\alpha \bar{v}^2}{2g} \quad \text{where } Z = z + Y \quad (6.24)$$

where:  $z$  = height of bed above datum (m)  
 $Z$  = height of water surface above datum  
 $Y$  = depth of water (m)  
 $\alpha$  = energy coefficient  
 $v$  = mean velocity of flow (m/s)  
 $g$  = acceleration due to gravity ( $\text{m}^2/\text{s}$ )  
 $H$  = total head (m)

From the principle of the conservation of energy the total head at the upstream section should be the same as at the downstream section. The difference between them, or head loss  $h_f$ , is a result of friction from the channel. With this under consideration the expression termed the Bernoulli energy equation can be written as:

$$Z_1 + \frac{\alpha_1 \bar{v}_1^2}{2g} = Z_2 + \frac{\alpha_2 \bar{v}_2^2}{2g} + h_f \quad (6.25)$$

The friction slope, or the slope of the energy line, of the reach between sections 1 and 2 may be defined as:

$$S = \frac{h_f}{L} = \frac{(Z_1 - Z_2) + \left( \frac{\alpha_1 \bar{v}_1^2}{2g} - \frac{\alpha_2 \bar{v}_2^2}{2g} \right) (1 - k_e)}{L} \quad (6.26)$$

Where:  $h_f$  = friction head loss  
 $(Z_1 - Z_2)$  = the measured surface water fall between sections 1 & 2;  
 $\alpha_1, \alpha_2$  = the velocity head coefficients;  
 $k_e$  = the energy head loss coefficient;  
 $\bar{v}_1, \bar{v}_2$  = the mean velocities at section 1 and section 2 respectively and are given by the ratio  $Q/A$  at the two sections;  
 $L$  = the length of the channel reach.

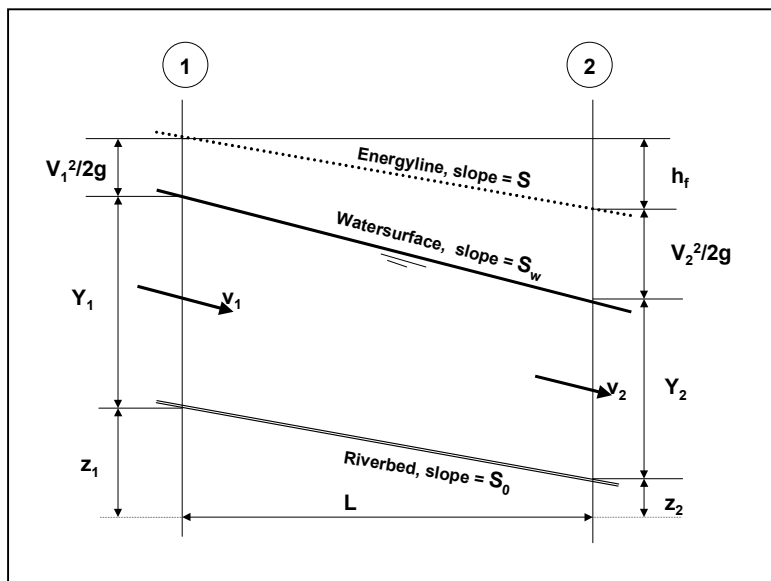

Figure 6.46:  
Diagram Illustrating the components of conservation of energy in an open channel

In equations (6.25) and (6.26) the energy coefficient ( $\alpha$ ) has been included. This is to correct for non-uniform distribution of velocities over a channel cross-section. Generally, the velocity is greater than the expression  $\bar{v}^2/2g$ . Often ( $\alpha$ ) can be assumed to be unity or differs very little from unity. However, in compound channels the value of ( $\alpha$ ) may be greater than unity. In such situations ( $\alpha$ ) may be estimated using the following formula:

$$\alpha = \frac{1}{A_T \bar{v}^3} \int_{A_T} v^3 dA \approx \frac{\sum (K_i^3 / A_i^2)}{K_T^3 / A_T^2} \tag{6.27}$$

- where:  $K_T$  = conveyance of the total cross-section
- $K_i$  = conveyance of the each sub-section of the channel
- $A_T$  = is the area of the total cross-section
- $A_i$  = is the cross-sectional area of sub-section

The energy head loss due to expansion or convergence of the channel in the measuring reach is assumed to be equal to the difference in the velocity heads at the two sections considered multiplied by a coefficient  $(1 - k_e)$  as shown in equation (6.26). The value of  $k_e$  is taken from Table 6.12.

Cross-section of characteristic of the reach	Value of $k_e$	
	Expansion	Contraction
Uniform	0	0
Gradual transition	0.3	0.1
Abrupt transition	0.8	0.6

Table 6.12: Eddy-loss coefficient for expanding and converging reaches

For a **uniform reach** the following equation should be used to estimate the friction slope:

$$S = \frac{(Z_1 - Z_2) + \left( \frac{\alpha_1 \bar{v}_1^2}{2g} - \frac{\alpha_2 \bar{v}_2^2}{2g} \right)}{L} \tag{6.28}$$

In all other cases the following equation should be applied to estimate the friction slope:

$$S = \frac{(Z_1 - Z_2) + \left( \frac{\alpha_1 \bar{v}_1^2}{2g} - \frac{\alpha_2 \bar{v}_2^2}{2g} \right) (1 - k_e)}{L} \tag{6.29}$$

In view of the uncertainty in  $k_e$ , non-uniform reaches should basically be avoided, particularly expanding sections.

### 6.6.3 ESTIMATION OF VELOCITY HEAD AND DISCHARGE

The discharge can be estimated using equation (6.21). If the reach is non-uniform the mean conveyance (K) is estimated using the geometric means of the conveyances of the two sections, thus:

$$Q = KS^{1/2} \text{ with } K = \sqrt{K_1 K_2} \text{ where } K_1 = \frac{1}{n_1} A_1 R_1^{2/3} \text{ and } K_2 = \frac{1}{n_2} A_2 R_2^{2/3} \quad (6.30)$$

The direct measurement of velocity, which is necessary to measure the slope of the energy line (S), is not possible using the slope area method so it has to be estimated by an iterative procedure.

A first approximation of the discharge Q is made assuming that the surface water slope is the same as the energy slope. Knowing the values of  $A_1$  and  $A_2$  it is possible to estimate the mean velocities at sections 1 and 2 as follows:

$$\bar{v}_1 = Q/A_1 \quad \text{and} \quad \bar{v}_2 = Q/A_2$$

Hence first estimates of the velocity head can be made and a new estimate of S made using either equations (6.28) or (6.29) depending on whether it is a contracting or expanding reach, and a new estimate of discharge made. This procedure is repeated until the current estimate of discharge is within 1% of the previous iteration estimate.

### 6.6.4 ESTIMATION OF MANNING'S COEFFICIENT

In view of the large range of natural conditions in river channels, the ability to estimate Manning's n values usually comes with experience. In some circumstances it may be possible to estimate the Manning's n values from well executed current meter gauging measurements. The values estimated can be extrapolated for use at higher levels provided there are no significant changes in the channel characteristics at the higher stages. In general the choice of the roughness coefficient is a combination of experience, estimations based on current meter gauging data and the use of a tabulation of roughness coefficients for channels of different types. Recommended Manning's n values for channels of different types are contained in Table 6.13 and 6.14.

Type of channel and description	Manning's Coefficient n
<b>Excavated or dredged</b>	
1) <u>Earth, straight and uniform</u>	
a. Clean, recently completed	0.016 to 0.020
b. Clean, after weathering	0.018 to 0.025
c. With short grass, few weeds	0.022 to 0.033
2) <u>Rock cuts</u>	
a. Smooth and uniform	0.025 to 0.040
b. Jagged and irregular	0.035 to 0.050
<b>Natural streams</b>	
Minor stream (top width at flood stage < 30 m) on flood plains: clean, straight, full stage, no rifts or deep pools	0.025 to 0.033
<b>Flood plains</b>	
1) <u>Pasture, no bush</u>	
a. Short grass	0.025 to 0.035
b. High grass	0.030 to 0.050

Type of channel and description	Manning's Coefficient n
2) <u>Cultivated areas</u>	
a. No crop	0.020 to 0.040
b. Mature row crops	0.025 to 0.045
c. Mature field crops	0.030 to 0.050
3) <u>Bush</u>	
a. Scattered bush, heavy weeds	0.035 to 0.070
b. Light bush and trees (without foliage)	0.035 to 0.060
c. Light bush and trees (with foliage)	0.040 to 0.080
d. Medium to dense bush (without foliage)	0.045 to 0.110
e. Medium to dense bush (with foliage)	0.070 to 0.160
4) <u>Trees</u>	
a. Cleared land with tree stumps, no sprouts	0.030 to 0.050
b. Same as above, but with heavy growth of sprouts	0.050 to 0.080
c. Heavy stand of timber, a few felled trees, little undergrowth, flood stage below branches	0.080 to 0.120
d. Same as above, but with flood stage reaching branches	0.100 to 0.160
e. Dense willows, in midsummer	0.110 to 0.200

Table 6.13 Values of Manning's n for different types of rivers

Type of material	Size of bed material (mm)	Manning's coefficient (n)
Gravel	4 to 8	0.019 to 0.020
	8 to 20	0.020 to 0.022
	20 to 60	0.022 to 0.027
Pebbles and shingle	60 to 110	0.027 to 0.030
	110 to 250	0.030 to 0.035

Table 6.14 Values of Manning's n for relatively coarse bed material and not characterised by bed formations

### 6.6.5 COMPOSITE SECTIONS

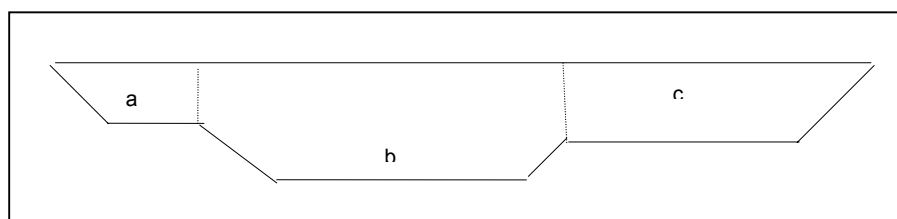

Figure 6.47: Sketch illustrating composite channel cross-section

Rivers in flood plains or compound channels have composite cross-sections such as illustrated in Figure 6.47 above. The conveyance for each component part of the section should be estimated and summed to obtain the conveyance factor for the whole section, thus:

$$K = K_a + K_b + K_c \quad (6.33)$$

### 6.6.6 STATE OF FLOW

After the final discharge has been determined the Froude number should be computed to evaluate the state of flow.

$$Fr = \frac{\bar{v}}{\sqrt{gd}} \quad (6.34)$$

where:  $\bar{v}$  = mean velocity  
 $g$  = acceleration due to gravity  
 $\bar{d}$  = mean depth of the cross-section, which is the ratio of the cross-sectional area and the surface water width

The slope area method may be used when the flow is sub-critical ( $Fr < 1$ ) and supercritical ( $Fr > 1$ ). However, if the state of flow changes in the reach from sub-critical to supercritical, or vice versa, there is cause for further examination of the data.

A change from supercritical to sub-critical flow will create a hydraulic jump in the reach with its uncertain energy losses. Whereas a change from sub-critical to supercritical flow might indicate a sudden contraction (with contraction losses not evaluated) or a free fall in the water surface which would result in a discontinuous water surface slope not related to discharge in the Manning equation. Where high-water profiles are obtained, the sharp drop or jump may be evident and will show the computed discharge to be at fault. A gradual transition from sub-critical to supercritical flow is possible and might be verified by a continuous water surface profile and the computed discharge may be assumed to be valid. However, it is strongly recommended that situations where the state of flow varies from sub-critical to supercritical or vice versa to avoid.

## 6.7 COMPARISON AND APPLICATION OF DIFFERENT FLOW MEASUREMENT TECHNIQUES

Sections 6.3 to 6.6 of the manual have elaborated on various methods of measuring flows in rivers, which are appropriate for conditions in India. In some circumstances more than one method will be deployed. For example the stage-discharge method requires the measurement of flows by current meter or some other means in order to derive the relationship between stage and discharge. The final choice of method will ultimately depend on a number of factors including, but not limited to the following:

- Site conditions;
- Cost - both capital and recurrent;
- Frequency of measurements required;
- The required accuracy;
- The value of the information being acquired;
- The period over which monitoring is required;
- Ease of installation;
- Maintenance requirements;
- Manpower requirements;
- Safety considerations.

In order to assist with the selection of appropriate streamflow measurement techniques, the advantages and disadvantages and applications of different methods have been summarised in Table 6.15, which follows. In the table also flow measuring structures have been included. The details of these structures can be found in Volume 4, Reference Manual on Hydrometry.

Table 6.15 Comparison and applications of different methods of stream flow measurement

Method/Accuracy	Continuous	Staffing	Maintenance	Cost	Physical limitations	Advantages	Disadvantages	Applications
Floats  (+/- 20%)	No	1 - 4  (river size and type dependent )	Minimal	Low	An estimate of flow can usually be made using floats for all but the very lowest flows.	Simple & easy to use  Cheap  Can be used when current meter gauging not possible	Less accurate than other methods  Estimating position of float in river section can be problematic	Where none of the other methods are possible or for quick reconnaissance measurement
Current meter gauging - All methods  (+/- 10%)	No					Simple, Robust, Reliable, Can be portable, Widely understood and accepted	Not suitable for very low velocities,  Can be time consuming, Point velocities only, not continuous	Derivation of stage - discharge relationships, investigation measurements, checking other methods
Current Meter Gauging -wading  (+/- 10%)	No	1 -2	Calibration and maintenance of current meter	Low	Low flows,  Depth < 1.0 m  0.03m/s < V < 1.0m/s	Simple, can be undertaken by only one person, cheap	Shallow rivers only	Low flow investigations, deriving lower end of stage-discharge relationship
Current Meter Gauging - bridges  (+/- 10 to 15%)	No	2 - 3	Calibration and maintenance of current meter and bridge outfit	Relatively low	All but extreme low and high flows.  Depth > 1.0 m  V > 0.03 m/s  at very high velocities can only position meter at surface	Simple, can be undertaken by two people, can cover almost full flow range, cheap	Can get skew flow and draw down occurring between bridge piers, sometimes each bridge span has to be considered as a separate channel. At high flows might only be able to measure surface velocities. Not safe to use on busy bridges where there is no footpath.	Derivation of stage - discharge relationships, investigation flow measurements. Can be used anywhere there is a suitable bridge
Current meter gauging - cableways - bank operated  (+/- 10%)	No	2 - 3	Cableway needs periodic checking and maintenance.  Calibration and maintenance of current meter	Relatively high capital costs	Width < 200 m (300m possible)  Depth > 1.0 m  V > 0.03 m/s  At very high velocities can only position meter at surface	On narrower rivers up to 200 m wide, cheaper and safer than manned trolley cableway system, safer than boat gauging	Not possible to use on wider rivers, say > 200 m, require depth and distance measuring counters, also suspension cable need electrical cable embodied in it to transmit pulses to bank from current meter	Gauging on narrower rivers, particularly important stage-discharge sites where no bridge available, always use when conditions allow in preference to manned trolley system

Table 6.15 (contd.) Comparison and applications of different methods of stream flow measurement

Method <sup>1</sup>	Continuous	Staffing	Maintenance	Cost	Physical limitations	Advantages	Disadvantages	Applications
Current Meter Gauging - cableways - manned trolleys  (+/- 10 to 15%)	No	4	Cableway needs regular safety checking and maintenance.  Calibration and maintenance of current meter	High capital costs of cableway construction	Width < 600 m Depth > 1.0 m $V > 0.03$ m/s  At very high velocities (> 4.0 m/s) it will probably not be in order for the operatives to man trolley	Can be used where there is no bridge and where it is too wide for bank operated cableway	Have to be designed to high factor of safety, operator safety sometimes at risk, not possible to use on very wide rivers, say greater than 600 m	On wider important rivers particularly for establishing stage - discharge relationships
Current meter gauging - boat  (+/- 15%)	No	4	Boat needs periodic checking and maintenance.  Calibration and maintenance of current meter. Boat cableways need regular maintenance	Moderately high capital cost. Cost can become considerably higher if boat cableway required.	Depths > 1.0 m $0.03\text{m/s} < V < 4.0\text{m/s}$	Can be used under a wide variety of conditions, the only way of current meter gauging very wide rivers where there is no bridge	Cannot be used at very high velocities due to safety considerations, positioning the boat where there is no cable or tag line can be problematic as can holding the boat on station.	Wide rivers where there is no bridge and it is not possible or economic to install cableway
Electromagnetic Current Meter  (+/- 10%)	No	Depends on method of deployment - see standard current meter	Requires checking prior to each gauging. Calibration once every three years.	Considerably more costly than conventional current meter	Limitations dependent on same methods of deployment as conventional current meter. Will however, measure velocities below min. response speed of current meters but uncertainties increase	Can be used in low velocity, shallow, high suspended solid and weedy conditions	Still to be fully proven  Point velocities only  Can be effected by electrical noise  Uncertainties considerably greater at low velocities	Special applications e.g. moving boat method, measurement of effluents with high suspended solids, very low flows i.e. shallow depths and/or low velocities
Stage-discharge (Rated sections)  (=/- 5 to 20 %)	Yes	1 - 4 depending on site	Gauge posts, stilling wells and other installations require regular checking and maintenance. Cross-section surveys	Costs dependent on type of stage measurement installation and gauging method.	Range effectively limited to current meter gauging limits. However, methods are available for extrapolating rating curves.	Continuous or frequent estimates of discharge, relatively low cost of establishment (dependent on gauging method), if stable control once stage-discharge relationship has been established only periodic check gauging required	Stage - discharge relationship derivation requires considerable current meter gauging effort can be unstable and/or insensitive, shifting controls problematic, can be effected by variable backwater	Most continuous/quasi-continuous flow measurement in India



Table 6.15 (contd.) Comparison and applications of different methods of stream flow measurement

Method <sup>1</sup>	Continuous	Staffing	Maintenance	Cost	Physical limitations	Advantages	Disadvantages	Applications
Structures  (+/- 5%)	Yes	1 - 2	Structures require to be kept free from debris and vegetation growth. Downstream and approach channels need to be kept clear of weed growth and other obstructions. Regular maintenance to repair crest and other structural damage,	High capital cost.	Narrow rivers only, say < 50 m and 100 m maximum.  Flow range is dependent on the modular limit unless a method of estimating non-modular flows is installed.	Highly accurate  require very little checking by current meter if working within their limits of application, can provide sensitive and stable controls	High capital cost  Limited stage and thus flow range  Require to undertake current meter gauging or some other method to estimate flows in non-modular range, only suitable for smaller rivers e.g. Western Ghats, can create upstream afflux problems	Special investigations on smaller water courses where a high accuracy is required, e.g. irrigation canals
Acoustic Doppler Current Profiler  (+/- 10%)	No	4	Normally requires return to supplier every 3 years for minor repairs and maintenance. Diagnostic checks can be undertaken using the ADCP software.	High capital cost.	Depths > 1.8 m  V < 4.0 m/s  Ideally suited for use on larger rivers. Upper velocity limit is based on safety considerations and not due to limitations of the technique.	Quick even on a very wide river can be assumed to be instantaneous measurement  Does not affect navigation  Boat does not have to move in straight line  Portable  A detailed picture of the bed and velocity profiles can be obtained	Not yet widely used  Equipment costly  High tech. - requires a relatively, highly skilled operator  Not possible to use from boat above 4.0 m/s for safety reasons  Can make large demands on internal battery power	On very large, important rivers e.g. at inter-state boundaries where other methods are not possible.
Slope-area method  (+/- 25%)	Usually no but could be continuous	1 - 2	Minimal	Low	Rivers flowing across full bed width. Expanding and very wide reaches should be avoided.	Easy to set-up  Post-flood peak estimation  Simple  Low cost	Not as accurate as other methods  Accuracy dependent on selection of roughness coefficient and other factors	Extreme flood peak estimation, where other methods not viable, where variable backwater is a problem

\* Typical discharge measurement uncertainties are contained in brackets under method.

---

## 7 EQUIPMENT SPECIFICATIONS

### 7.1 INTRODUCTION

For the development of comprehensive and user friendly data bases it is important to pay special attention to the standardisation of procedures and equipment for collecting this data. In this context, a set of specifications for hydro-meteorological, hydrometric and water quality equipment has been compiled by the R.D. Directorate of the Central Water Commission, in collaboration with HP Consultant, DHV/Delft Hydraulics. **This set is meant to be a guideline for procurement and is not thought to be complete, nor is it thought to be applicable for each and every application.** The general specifications for stage and streamflow measurement instruments and equipment are contained in a special Volume: 'Equipment Specification Surface Water', which is regularly updated, to keep track with the latest developments in the field of hydrometry and electronic devices.

It is important, prior to investing in hydrometric equipment, particularly DWLRs and logging systems, that a clear, detailed definition of user requirements appropriate for India's conditions is prepared. Also, the specifications (What the producer should comply with) shall be, where necessary, site specific. Therefore, some brief guidelines concerning the preparation of technical specifications are contained in Section 7.2.

There is a large number of suppliers of hydrometric equipment. Many of these are highly reputable, honest companies who produce good quality equipment. However, there are other companies whose sales personnel will make claims about their equipment, which cannot be substantiated by their own specifications and/or performance in the field. Sometimes a type of instrument or technique gets a bad reputation for one or more of the following reasons:

- The supplier makes claims about the instruments performance beyond its capability;
- The selected instrument is poorly made;
- The user tries to use it for applications outside the instrument's specification;
- The users field staff are not properly trained and/or have a poor work attitude;
- The operation and maintenance requirements are misunderstood by the user.

The advantages and limitations of the instruments, equipment and techniques described in this manual have been highlighted in the relevant chapters. In this regard it is important that the appropriate instrument is selected for the application required. When choosing appropriate hydrological equipment, and in particular DWLRs, **the overall cost of ownership over the life of the system needs to be carefully considered.** The initial capital cost outlay needs to be balanced against the expected life of the product, the operating and maintenance costs, the risk of data loss plus any benefits such as convenience or time savings (manpower costs) provided during the operating life of the system. The capital cost of a system may be the lowest. However, higher operating, maintenance and other costs over a number of years may push the overall cost of ownership higher than an alternative system, which has a greater capital cost of purchase.

It is very important that manufacturer's specifications and jargon are fully understood prior to evaluating tenders or bids for the supply of hydrometric equipment. Those suppliers who do not meet the specification should not be considered. It is also very important that the instruments and equipment under consideration should have a well-proven 'track record' under similar conditions to those in which they are to be used. In addition manufacturers should be able to demonstrate that they have good manufacturing, quality assurance and calibration facilities and they have a high level of quality assurance procedures in place. Section 7.3 provides some guidelines on the interpretation of manufacturers specifications and the quality of their product and their quality assurance procedures.

All the instrument types and techniques described in this manual have been widely and successfully used in a variety of harsh climatic and hydrological conditions similar to those experienced in Peninsular India. Therefore, provided the instruments used are of a good quality and soundly maintained and the staff are well trained and motivated, it should be possible to obtain the best possible data quality.

## **7.2 PREPARATION OF STAGE AND STREAM FLOW MEASUREMENT INSTRUMENTATION AND EQUIPMENT TENDER SPECIFICATIONS**

### **7.2.1 INTRODUCTION**

In Chapter 3 on Network Design and Chapter 4 on Site Selection, very much emphasis is put on the definition of monitoring objectives. These have to be clearly defined before siting, designing and specifying equipment for a stage or flow measurement station. These objectives will determine factors such as location and thus site conditions, required accuracy, frequency of measurement, measurement range, budget and operation and maintenance capability. Therefore, the objectives have to be clearly defined prior to preparing specifications for hydrometric instruments and measurement equipment. Some of the objectives which are of particular relevance to instrument and equipment selection are reproduced from Chapter 4 for ease of reference, as follows:

1. What is the purpose of the station? e.g. planning and design of major water supply scheme, pollution monitoring, flood forecasting etc.
2. Define the required location of the site i.e. what are the most upstream and downstream limits e.g. the station might have to be located between two major tributaries;
3. Does the full flow range require monitoring or are low or high flows of greater importance?
4. What level of accuracy is required?
5. What period of record is required and what frequency of measurement is desirable?
6. Who will be the beneficiaries of the data?
7. Are there any constraints such as access and land acquisition problems and cost limitations?
8. Is a particular streamflow measurement methodology or instrument preferred?

### **7.2.2 SITE SURVEYS AND INSTALLATION PLANNING**

Even the simpler and more widely used and understood hydrometric equipment requires an understanding of probable site conditions. For example even the simple, basic stage post requires a knowledge of the cross-section so that the number and lengths of gauge plates can be determined. Level range and depths to bed level is also important in selecting current meter suspension cable and the length of connecting cable between the current meter and the revolution counter.

The first step in the specification process is therefore to undertake the **site surveys** (Section 4.2). This should result in some or all of the following:

- Cross-section(s) of proposed stage and current meter gauging sites;
- Level range;
- Distance from proposed position of sensor to instrument house (DWLR's);
- Definition of measurements and equipment required;
- Definition of operating conditions e.g. temperature ranges, susceptibility to moisture ingress or flooding, type of instrument housing required, is stalling well possible and necessary;
- A basic understanding of nature of flow - turbulent, flow circulation, very high and/or very low velocities;
- Indication of composition of water - high suspended solids, saline, air bubbles, corrosive.

- Specific information relating to DWLR installations - e.g. is attachment to a bridge pier or a wall possible, in the river bank situation what type of instrument and cable protection will be required.
- Series of clear site plans and photographs, types of banks, topology, erosion/sedimentation plants, animals/ rodents insects.

On completion of the site surveys it is then possible to **plan the installation**. During this planning phase the following will be determined:

- Details of the proposed installation(s).
- The type and numbers of the measurement equipment required.
- Materials required e.g. cable protection tubes, instrument house, padlocks and other security fixings, cable fixtures.
- The measuring ranges.
- Accuracy and resolution required.
- Ancillary equipment requirements e.g. suspension cables.

### 7.2.3 TENDER PACKAGES

Once the installation planning is complete, a decision can be made on how to divide the work into suitable tenders. In this regard the following divisions might be appropriate:

Tender 1:	Civil works e.g. stilling wells, structures, buildings and cableway towers
Tender 2:	Standard hydrometric equipment e.g. current meters, AWLR's etc., winches, cableways
Tender 3:	Electronic stage monitoring equipment i.e. DWLR's,
Tender 4:	Special equipment to be tendered separately e.g. echo sounders, ADCP, reservoir survey equipment

Even though it is preferable to keep the number of packages to an acceptable minimum, it has to be recognised that hydrometric equipment is extremely specialised. There are very few single manufacturers who make all the necessary equipment, for a stage-discharge station and these are mainly from Europe and the USA. For example you could have a very good manufacturer of DWLR's who does not make current meters. Therefore care has to be taken in designing the package to ensure good companies are not excluded because the package is too wide. Also if the package is too wide there is the danger that companies will include in their bids another company's equipment with which they are not familiar.

**It is essential that the supplier has extensive and traceable experience with the offered equipment.**

When large numbers of a particular type of instrument are required it is sometimes a good idea, particularly if the instrument is relatively new technology, to split the main package into several smaller phased packages. For example, instead of buying 60 instruments of the same type immediately, possibly only buy 20 in the first instance. This means if the successful supplier for the first package provides a poor service or equipment, there is an opportunity to exclude him from future bidding for the remaining equipment. It could be highly beneficial (in terms of resulting data) if the procuring agency obtained in-house instrumentation expertise.

Once the tender packages have been agreed the necessary tender/bid documents can be prepared. In preparing the technical specifications it is important to pay due attention to the points raised in Sections 7.2.4 to 7.2.7 below

## 7.2.4 RESOLUTION AND ACCURACY

It is very important to state in the specification document the measuring **resolution** and **accuracy** (measurement uncertainty) required. There is a subtle, but important difference between the definition of the terms 'resolution' and 'accuracy' for water level measurement. Also, sometimes people erroneously use one term when they really mean the other.

'Resolution' means the degree of precision of measurement units that can be obtained with any one method of measurement e.g. the minimum resolution on a graduated metric ruler or tape is normally 1 mm i.e. it is divided into 1 mm intervals. The 'accuracy' of that measurement, however, is entirely dependent on how good the calibration of the ruler was during production and also on how accurately the human eye/brain combination can read the scale. This is often a function of both the viewing distance and eyesight.

For DWLR's accuracy is usually expressed as a percentage of Full Scale Output (FSO) or Full Range Output (FRO) which mean the same thing. For example most modern pressure sensors have an accuracy of +/- 0.1% of FSO. This means if the measuring range is 10 m it will measure to +/- 10 mm i.e. the absolute accuracy is +/- 10 mm. However, if the same sensor was only measuring over a scale of 0.5 m, it would still have an absolute accuracy of 10 mm, so the percentage accuracy would increase to  $10/500 \times 100 = +/- 2\%$  of that scale. It is very important to specify the measuring accuracy required both in absolute and % of FSO terms. Normally for most stage-discharge river applications an accuracy of +/- 10 mm is required or desirable.

## 7.2.5 HYDROMETRIC SENSOR AND EQUIPMENT SELECTION CRITERIA

When preparing specifications and selecting an instrument or measurement method it is essential that due cognisance is given to the following selection criteria:

- Water level or flow measurement sensor design factors
- Installation and site requirements
- Operation and maintenance

### ***Water level or flow measurement sensor design factors***

1. Sensor size i.e. dimension requirements. Are there any size constraints e.g. narrow piezometer tube.
2. Power requirements and autonomy. At some dam sites power supply might be available. How long should the instrument and its associated equipment be able to run before changing the batteries?
3. Mode of operation - continuous or pulsed
4. Processing method
5. Discrimination methods - identification and rejection of spurious signals
6. Assumptions e.g. velocity of sound for Doppler's and ultrasonic water level sensors
7. Output e.g. 4 - 20 ma

### ***Installation and site requirements***

1. Site selection requirements - what special features does a particular instrument require in terms of physical conditions?
2. Ease of installation - generally the simpler the better.
3. Environmental/aesthetic considerations - is the instrument going to create environmental problems?
4. Power requirements - does the instrument require a main power supply. If so this may exclude its use in many hydrometric installation

5. Diagnostic features
6. On site calibration requirements
7. Weatherproofing, environmental protection- does it require a special instrument house or does it come with its own protection

### ***Operation and maintenance***

1. Power - how often do batteries need changing or charging depends on Power consumption during operation/stand by and while communicating.
2. Logging facilities - ease of data handling, compatibility with other systems;
3. Maintenance requirements - frequency of visits, river channel maintenance requirements e.g. removal of silt, equipment maintenance;
4. Back up support - what maintenance and support services can the supplier offer? Where is the supplier located relative to the sites concerned?

## **7.2.6 INSTRUMENT AND EQUIPMENT SPECIFICATIONS**

The Specifications are covered in the 'Equipment Specification Surface Water' as a separate Volume. It includes minimum requirements for all types of hydrometric equipment used in the HIS. As already indicated it is necessary in many cases to be site specific. This section provides some guidance on the type of information to provide in the specification for the following types of equipment:

- Staff gauges
- Digital water level recorder (Pressure sensor/Shaft encoder type)
- Current meters and accessories.

The type of information to be provided is elaborated below.

### ***Staff gauges***

The specifications should include the following:

- Measuring range;
- Number;
- Graduation pattern;
- Material;
- Colour;
- Dimensions including length;
- Resolution and accuracy of manufacture;
- Any fixing arrangements e.g. bolt holes/slots.

### ***Autographic water level recorders***

- Measuring range;
- Drum or strip chart;
- Drum/chart speeds;
- Scales;
- Drive - spring or battery;
- Battery lifetime/autonomy;
- Instrument housing to be provided? what IP standard?

---

***Digital water level recorder (Pressure sensor type)*****Sensor**

- Measuring range;
- Accuracy;
- Size/weight;
- Long term stability;
- Level of protection - IP level of protection;
- Moisture ingress protection
- Corrosion protection

**Recorder (or Data Logger)**

- ADC and Storage resolution;
- Measuring intervals;
- Memory;
- Back-up;
- Storage capacity;
- Parameters to be recorded and stored e.g. date, level, time;
- Clock;
- Power supply and battery life;
- Operating temperature range;
- Interface for data communication.

**Electronics enclosure**

Material, level of environmental/ingress protection, dimensions, connectors, corrosion resistance.

***Cable specifications*****Data retrieval system**

Type, capability, LCD display required?, capacity to offload data, power supply, back-up battery, operating temperature and humidity ranges. Suitability, compatibility and user friendliness of software.

***Current meters and Accessories*****Sensor**

- Type - cup or impeller;
- Velocity and depth measuring range ;
- Accuracy;
- Contact e.g. 1 rev per pulse;
- Calibration and certificate requirements.

**Counter/Timer**

- Type of display e.g. LCD;
- In built timing facility yes or no?

- 
- Fixed pulse counter option?
  - Counting range;
  - Time resolution;
  - Temperature range;
  - Power supply;
  - Protection levels, IP standard.
  - Sturdiness;

#### **Wading rods**

- Number;
- Measuring range;
- Length of each section of rod e.g. 1 m;
- Graduations e.g. 10 mm;
- Material;
- Current meter positioning rod/device e.g. positioning meter at 0.6 D.

#### **Bridge outfit**

- Measuring range - height of bridge (top of parapet) to lowest point;
- Material;
- Weight of current meter and fish-weight;
- Suspension cable incorporating electrical connection wire between meter and pulse counter;
- Depth counter or other means of measuring depth;
- Angle of suspension indicator/protractor;
- Current meter positioning indicator e.g. 0.6 D;
- Type of jib - length, other dimensions.
- Breaking strength of cable;
- Torsion flame underload;

#### ***Bank operated cableway***

It is recommended that a detailed cross-sectional drawing of each site is supplied with the tender documents, clearly indicating the proposed position of the cable stanchions, the ground conditions, the maximum flood level and other pertinent information. The onus can then be on the supplier to determine cable lengths, stanchion sizing etc. Most reputable suppliers of this type of equipment will provide such a service. Other information to be provided in the specification could include:

- Measuring range - depth and maximum width/span;
- Weight of current meter and fish-weight;
- Suspension cable incorporating electrical connection wire between meter and pulse counter;
- Depth and distance counter resolution, normally 0.01 and 0.1m respectively;
- Angle of suspension indicator/protractor;
- Hand winch or motor (diesel or electric).
- Safety factors?



### 7.2.7 OTHER ITEMS TO BE INCLUDED IN THE SPECIFICATIONS

Other items to be included in the Specifications include:

- Company reputation, facilities, authentication and accreditation;
- Installation, commissioning and training;
- Acceptance;
- Warranty, service, maintenance and spare parts;
- Tender evaluation criteria;

These items are elaborated below.

#### ***Company Reputation, Facilities, Authentication and Accreditation***

It is very important, particularly for large orders that the company concerned has a good, proven track record with the equipment they are selling. Therefore, in the tender specification the following information should be requested:

Company background - history, size, how long has it been manufacturing and/or supplying the very instrument concerned, back up support facilities in India. Official published company accounts for the last three years is sometimes a useful indicator of company credibility;

Project profiles of the same equipment supplied over the last five years for similar applications in same environmental conditions;

A list of references i.e. names and addresses, telephone and fax numbers of previous customers, e-mail addresses where applicable. Experience has indicated that it is essential that some of these references are followed up (see Section 7.3);

Details of instrument calibration facilities;

Details of quality assurance procedures - have these been accredited i.e. have these been approved by a recognised accreditation bureau/organisation?

#### ***Installation, Commissioning & Training***

It is very important that the tender document/specification is clear about what is expected from the supplier on delivery. Is the contractor or supplier expected to undertake installation, commissioning and training? The more effort the supplier has to expend after delivery will generally have an increased knock-on effect on the overall cost. Conversely, particularly with modern, less familiar equipment there is a danger if the equipment is to be installed by the purchasing organisation that problems can occur. The amount of effort expended by the supplier at the installation stage is a function of the complexities of the equipment and the capabilities of the organisation concerned.

The following suggestions are offered as a guide:

<u>Typical equipment</u>	<u>Effort by Supplier</u>
1. Staff gauges, basic current meter sets, floats, basic levelling instrument, boat & OBE	No on site installation, commissioning or training required
2. AWLR's, bridge outfits, boat outfit, echo sounders, electromagnetic current meter,	Installation/demonstration/commissioning/training at one site
3. Electronic levelling instruments, positioning equipment (DGPS)	May require more training
4. DWLR's, shaft encoder	Installation, commissioning and training at 8 - 10 sites in each region/division
5. Cableways, ADCP, reservoir capacity survey equipment	Complete installation, commissioning and training at each site or for each unit

### ***Acceptance***

Irrespective of whether the equipment is to be installed by the supplier or not, it is important that some form of acceptance procedure is put in place. Even simple equipment like gauge plates should be inspected and approved on delivery. The acceptance routines will be instrument/equipment specific but should be more than just a number count against an inventory. For example every fifth gauge plate could be checked for quality by comparing the distance measuring graduations with a standard, accurate steel tape. Other instruments such as DWLRs will require more complex acceptance procedures. As a general policy all instruments, equipment, software deliverables should be submitted to a acceptance protocol. Where appropriate instruments will only be accepted with the necessary calibration certificates and other supporting documentation. The quality of the finished product will be up to the standard stated in both the tender and supplier's specifications. It should be made clear in the tender specification that the supplier will not receive full or final payment, depending on the agreed payment schedule until such time as a formal acceptance procedure has been successfully completed.

### ***Warranty, Service, Maintenance and Spare Parts***

Some hydrometric equipment of the quality required is not readily available, on local markets. Therefore, equipment might have to be purchased from elsewhere in the country or internationally. It should be clearly spelt out in the tender document what the successful supplier will be expected to provide in the way of back-up services.

Generally it should be expected that the supplier will have an office or fully trained Agent within each State where his equipment is installed. This office should be able to provide adequate support facilities including replacement instruments, spare parts, servicing, maintenance contracts and further training. Most reputable manufacturers will offer a 12 months full warranty period or more and sometimes a further two years of reduced warranty, but this should be confirmed.

### ***Tender Evaluation Criteria***

It should be made clear in the tender documents that **only equipment meeting the specifications in their entirety will be considered**. Also, it should be clearly emphasised that purchase cost will not necessarily be the overriding factor in the evaluation of tenders. Moreover any bid missing parts of specifications or not responding to all the specification details requested, whether deliberately or not, should be treated as non-compliant with the tender requirements. A manufacturer/vendor having a poor performing record or offering a product that is poorly performing under Indian conditions may be thoroughly scrutinised.

---

## 7.3 INTERPRETATION OF EQUIPMENT SPECIFICATION AND ASSESSMENT OF PRODUCTS AND SUPPLIERS

### 7.3.1 INTERPRETING EQUIPMENT SPECIFICATIONS

The interpretation of manufacturer's specifications for conventional hydrometric equipment such as current meters, suspension cables and cableways is relatively straight forward. However, the advent of modern electronic instruments and in particular DWLR's has resulted in new terminology and jargon.

Contemplating the use of electronics-based technology takes many hydrologists and hydrometrists into unfamiliar territory. There is likely to be rather more to do than simply make a decision regarding "most appropriate technology for the application". Even if that choice is straightforward, there will be competing products to be considered, each hailed by its salesman as (a) totally appropriate to your application and (b) the best and most cost-effective in its class. Some unfamiliar terms may be encountered in product literature that, though they may be intended to be informative regarding the performance that the manufacturer is claiming for his device, may sometimes be selectively so. "Specmanship" is a highly developed art that seeks predominantly to highlight the virtues that the supplier sees in his product, while drawing as little attention as is decently possible to its limitations.

All trades and professions use jargon as a convenient shorthand that is totally meaningful to the initiated. To outsiders, it may be at best confusing, at worst incomprehensible. A typical **Product Specification** or **Calibration Certificate** for a DWLR of the pressure sensor type might contain such terms as:

- FSO (Full Scale Output) or FRO (Full Range Output)
- BSL (Best Straight Line)
- Hysteresis
- Linearity
- Temperature Error Band
- Thermal Zero Shift
- Thermal Span Shift
- Compensated Temperature Range
- Zero Offset
- IP standards

There may also be unfamiliar measurement concepts such as the "**Bar**" to be grasped, as a unit of measure for pressure, coupled with a need to be able to interpret this as "**Depth of Water**". There will also be "**Gauge Pressure**" to be distinguished from "**Absolute Pressure**", if Specifications are to be fully understood. For this reason the terms listed above have been defined and briefly explained in the section on DWLR's of the pressure sensor type, in Sub-section 6.1 of this manual. Whenever possible the specifications for instruments, which have not been used before, should be interpreted by an experienced hydrometric instruments specialist with an electronics and/or physics background.

### 7.3.2 EVALUATION OF SPECIFICATIONS

The evaluation of the specifications comprise the following items:

- Technical specifications
- Company background and reputation, qualification criteria
- Quality assurance, certification and accreditation
- Installation, commissioning, training and back-up support.

---

These items are dealt with below.

### ***Technical Specifications***

In order to assist with the evaluation of the technical specifications it is recommended that a standard evaluation form is prepared which can be completed for each tenderer. This form should list the various attributes specified in the tender document, the required specification and the specification of the suppliers equipment. This is particularly important for evaluating specifications for equipment of an electronic nature such as DWLRs. The form should be used to assist with the evaluation process. Where equipment fails to meet the tender specification this should be clearly indicated on the form.

The form is divided into 11 main sections, namely:

1. General information;
2. Pressure Measurement;
3. Data logger;
4. Electronics enclosure;
5. Cable;
6. Data Retrieval System (DRS);
7. PC utility software;
8. DWLR spares
9. DRS spares;
10. Maintenance;
11. Training;
12. Any special features.

Only instruments or equipment which **fully meet the requirements** of the tender specifications should be considered for purchase.

### ***Company Background and Reputation***

The organisation tendering for the supply of equipment will be asked to provide background information such as quality assurance procedures, calibration facilities, financial standing, details of recent sales and installation of equipment particularly in similar hydro-meteorological conditions to those experienced in Peninsular India. Every attempt should be made to authenticate this information, particularly if the company concerned is unknown or not well known to the organisation letting the tender. Some of the Company's quoted references should be contacted at random to obtain an independent opinion on the performance of the equipment based on the experiences of other users. The financial stability of the company and its potential longevity are also important considerations. No organisation wishes to commit themselves to a large order of hydrometric equipment, only to find that the company concerned is dissolved shortly after delivery, resulting in a cessation of back-up support.

### ***Quality Assurance, Certification and Accreditation***

Prior to placing a large order for DWLRs or similar electronic based hydrometric equipment, the organisation letting the tender should satisfy themselves that the company concerned has adequate quality assurance procedures already in place. In some countries, suppliers will have manufacturing and calibration facilities, which will have been certified by an appropriate independent bureau or organisation to comply with a traceable national or international standard. In such circumstances the buyer should be reasonably confident that the quality required will be achieved. However, in India to date, despite the presence of a well-established standards bureau, such procedures are not widely established.

Until such procedures are in place, particularly where large orders of equipment are involved, some form of inspection procedure should be established. In the first instance suppliers will be asked at the tender stage to indicate their quality assurance and calibration procedures. In particular with regard to the latter it is important that they specify how the instrument calibration is undertaken and who undertakes this work if it is not done in-house.

If a company is one of the favourites to be awarded an equipment tender then consideration should be given to inspecting their manufacturing and calibration facilities. This inspection should be undertaken by an experienced instrument specialist with electronics' background.

If some key instrument components are bought in from an external source (third party), attempts should be made to also ascertain the standing of that company and their quality assurance procedures.

### ***Installation, Commissioning, Training and Back-up Support***

Care should be taken to ensure that the supplier has committed himself to the necessary installation, commissioning and training requirements. The suppliers concerned should clearly demonstrate that they have the necessary staff to complete the work in the time-scales available. The locality of key staff should be established and supported with CVs and technical certificates where appropriate. The supplier should provide documentary evidence that he has an established office/agent within a reasonable distance/travel time from where the equipment is to be installed.

## **7.4 EQUIPMENT SPECIFICATIONS**

In the Volume: 'Equipment Specification, Surface Water' specifications are provided for the following hydrological equipment:

1. Staff gauge (IS 4080-1994)
2. Level indicator tape
3. Electrical level indicator tape
4. AWLR, Float type (IS 9116-1979)
5. DWLR, Pressure type
6. DWLR, Float with shaft encoder
7. Current meter, cup-type (IS 3910-1992, IS 4073-1967 and ISO 3454-1975)
8. Current meter, pygmy-type (IS 3910-1992)
9. Current meter, propeller-type (IS 3910-1992, IS 4073-1967 and ISO 3454-1975)
10. Pulse counter
11. Electronic stopwatch
12. Portable echo-sounder
13. Bathymetric system
14. Hydrographic echo-sounder
15. Sound velocity calibrator
16. Differential GPS
17. Laptop computer
18. Bathymetric software
19. Portable generator
20. Discharge measuring system
21. Acoustic Doppler Current Profiler
22. Electromagnetic current meter
23. Compass

- 
24. Moving boat software
  25. Survey equipment
  26. Theodolite (IS 2976-1964 and IS 8330-1997)
  27. Levelling staff (IS 11961-1986, A6 of IS 617-1975, IS 292-1983 and A6 of IS 627-1975)
  28. Auto level (IS 8330-1997 and IS 4590-1980)
  29. Laser distance meter
  30. Bridge outfit (IS 6064-1971)
  31. Boat outfit (IS 6064-1971)
  32. FRP boat
  33. FRP catamaran
  34. Aluminium boat
  35. Outboard engine
  36. Boat engine
  37. Tent (IS 989-1990)
  38. Total Station (tripod: IS 8330-1997)
  39. GPS L1 Receiver
  40. Digital level (tripod: IS 8330-1997)
  41. Data retrieval system
  42. DWLR, Bubbler type
  43. FRP boat (5.5 m)
  44. Steel boat (5.5 m)
  45. Steel boat (8 m)
  46. Electronic current meter (for wading use)
  47. Motor launch

It is noted that in the cause of time new specifications may be drafted. Hence, always consult the latest update of 'Equipment Specification Surface Water'.

## 8 STATION DESIGN, CONSTRUCTION AND INSTALLATION

### 8.1 DESIGN AND INSTALLATION CRITERIA - WATER LEVEL MONITORING

#### 8.1.1 STAFF GAUGES

Staff gauges are the basic water level monitoring tool. **They are required at all measurement sites since they are used as the reference check with which to set up an AWLR or DWLR** i.e. in most circumstances the AWLR or DWLR should be set up to read the same as the staff gauge. General guidelines and suggestions are presented to assist in the design.

#### *Definitions*

Gauge plates can either be fixed on the riverbank by means of mounting poles or to structures such as bridge piers or weir wing walls. The terms staff gauge, stage gauge, gauge plate, gauge board and gauge post are often used when making reference to stage measurement. Sometimes they are used to mean the same thing, at other times to mean slightly different parts of a staff gauge installation. This can sometimes lead to confusion. Therefore, the following definitions are given to avoid confusion in this chapter of the manual.

**Stage or staff gauge:** the complete installation, which is installed so that manual measurements of stage and/or water level can be made. The complete installation consists of a gauge plate and gauge post and/or gauge board.

**Gauge plate:** this is the graduated measuring plate, which can be made from enamelled steel or glass reinforced plastic (fibreglass). This what is fixed to the gauge post or wall (by means of gauge board).

**Gauge post:** metal, concrete or timber post, which is usually set in a concrete foundation block, to which the gauge plate can be fixed.

**Gauge board:** when installing gauge plates on walls and bridge piers it is advisable to fix a wooden backing board to the wall or bridge pier to which the gauge plate can be fixed i.e. it is usually not advisable to fix the plate directly to the concrete, brick or stonework.

#### *Installation criteria*

The exact method of installation will depend on current practice, site conditions and most suitable material available. However, the following installation criteria are offered as a guide.

1. The staff gauge(s) should be placed near the bank of the river so that they can be read directly. Whenever possible they should be positioned so that the observer can make readings at eye level. This is not always possible when using bridge piers.
2. Where very turbulent, high velocity conditions occur, it is sometimes advantageous to construct a stilling bay in the bank, which dampens the effects of turbulence, and oscillations in the main channel. Also, this can reduce the bow wave effect round the gauge at high velocities. The gauges should be as streamlined as possible to reduce this effect.
3. When installed on river banks the gauge plates should be fixed to steel (either angle iron or piles) or concrete supports/fixing posts. These should be fixed in concrete foundation blocks to try and prevent sinking, tilting and/or being washed away. The depth of the foundations will depend on specific site conditions. However, it is recommended that these should never be less than 0.5 m deep.

4. It is essential that the site selected for the installation of staff gauges has stable banks i.e. whenever possible erosion prone banks are avoided. Bank stabilisation should be undertaken to stabilise the banks if necessary. One solution, which is used effectively in some states, is to install the gauge posts in a series of steps on built-up terraces, which are protected from erosion by flood protection works e.g. revetment stone.
5. Slotted, fixing boltholes should be provided in steel gauge posts so that fine adjustment of the gauge plates can take place to set them at the correct level and to reset them when required. Also, this can facilitate the removal of the gauge plates for maintenance purposes as well as adjustment. If concrete posts are used it is not usually practical to install adjustment slots. Therefore, for such installations the adjustment slots should be provided in the gauge plate.
6. When fixing to bridge piers or wing walls a suitable backing plate or board (gauge board) should be provided. The gauge board should be attached to the surface so as to provide a truly vertical face on which to mount the gauge plate. The backing board should be fixed securely to the wall. If possible, particularly with new constructions and purpose built gauging stations, **the gauge boards should be recessed into the walls so that the plates are flush with the wall faces.**
7. Where the range of water levels exceeds the capacity of a single vertical gauge section, additional sections are installed on the line of the cross-section normal to the direction of flow.
8. It is important that the graduations of a vertical staff gauge are clearly marked on the gauge plate. The numerals shall be distinct and placed so that the lower edge of the numeral is close to the graduation to which it refers.
9. The gauge plates should be manufactured in suitable lengths (usually 1.0, 1.5 or 2.0 m) with the face of the scale not less than 100 mm wide.
10. The smallest marking should be normally 10 mm but reading to the nearest +/- 2 mm should be possible by interpolation if the gauge can be approached to within 1 m.
11. The markings of the sub-divisions shall be accurate to +/- 0.5 mm and the cumulative error in length shall not exceed 0.1% Or 0.5 mm, whichever is greater.
12. On receipt from the manufacturer/supplier each delivery of gauge plates should be quality checked. It is recommended that the dimensions of at least one in every five gauges are checked using a high, quality steel tape.
13. A specification for a standard gauge plate (staff gauge) is contained in 'Equipment Specification Surface Water'. This specifies enamelled plate as the appropriate material. However, fibreglass (GRP) has been found to be a successful material in other countries with a similar climate and conditions to India and could be used as an alternative material if desired.
14. Some typical staff gauge installation arrangements are shown in Figure 8.1.



*Figure 8.1:  
Typical Staff Gauge Installation Arrangements*



### 8.1.2 BENCH MARKS

Every water level/stage monitoring station irrespective of type should be equipped with at least one permanent site benchmark.

It is recommended that if there is a national grid benchmark (GTS) of a good quality within 5 km of the site then one permanent site benchmark should be established. Whenever possible this should be located within 500 m of the main set of reference staff gauges but above the maximum flood level and away from other potential sources of damage e.g. vehicular access tracks. This benchmark should be linked to the GTS network by double levelling from the nearest reliable national grid benchmark.

If the distance to the nearest reliable GTS bench mark is greater than 5 km, then two independent bench marks should be established in the close to the main set of staff gauges but at separate locations. In the first instance these bench marks should be double levelled relative to each other by means an arbitrary datum e.g. assume one bench mark is at 100 m, until such time as it is possible to link them both to the GTS system. The benchmarks should be linked to the GTS system by double levelling as soon as possible after their construction.

Bench marks should be of a strong permanent construction of the same or a similar standard to the Indian, CWC Musto type or 'D' type bench marks. One drawback of these benchmarks is the fact that they are flat. It is better to have pointed or a clearly defined apex on a bench mark e.g. a bolt set securely in concrete makes a good bench mark. Therefore consideration should be given to revising the Musto design to install a bolt or similar in the top of the bench stone to be the reference point.

Benchmarks should not be attached to stilling wells or their instrument housings since these are subject to bank subsidence. In this regard the benchmarks should not be constructed directly adjacent to a riverbank or other feature which is liable to movement.

### 8.1.3 STILLING WELLS

The function of the stilling well is to:

1. accommodate the instrument and protect the float system;
2. to provide within the well an accurate representation of the water level in the channel;
3. to damp out oscillations of the water surface.

The stilling well is usually constructed for the installation of the float type sensor, which can record by means of a chart or a shaft encoder.

Stilling wells can either be located in the bank or fixed to a bridge pier or an abutment. When placed in the bank the well is connected to the channel by intake pipe(s). When placed directly in the channel, the intakes are usually in the form of holes or slots cut in the sides.

#### ***Design criteria***

The following general guidelines which are based on current International and other accepted practice should be followed whenever possible:

- a) Whenever possible the well should not interfere with the flow pattern in the approach channel.
- b) If the stilling well is monitoring water levels upstream of a section or artificial control it should be located far enough upstream to be outside the influence of drawdown at the control.

- c) The well shall be watertight such that water can only enter or leave by means of the intake hole(s).
- d) The well shall be installed vertically and should be designed to allow the free movement of the float for the anticipated range of levels. Many sites in India require monitoring of a wide range of levels. In such circumstances the counterweight could become submerged. The design of the float and counterweight system should allow for this. Advice should be obtained from the manufacturer of the sensor on the impact such submergence could have on accuracy.
- e) The dimensions of the well shall be large enough to accommodate all the instrumentation to be installed. Normally the clearance between the walls and the float should be at least 75 mm. In situations where more than one recorder is to be installed in the same well, the clearance between the two floats should be at least 150 mm. It is advisable for permanent, bank stilling wells to make the dimensions of the well large enough for safe entry for de-silting and other maintenance purposes. In this regard an internal diameter of 1.5 m is recommended. In addition it is recommended that the provision of step irons is allowed for in the design for access purposes. For bridge and wing wall installations, not prone to siltation, a diameter of 0.5 m will normally suffice. It is normal to install such stilling wells on the downstream faces of bridges. This type of bridge installation is already in use in a number of States so type designs are already available. It is essential to ensure that sufficient fixing brackets of the correct strength are used to attach the stilling well to the bridge pier. Whenever possible bridge stilling wells should be fixed to the support piers and not the bridge deck to avoid problems caused by traffic vibration.
- f) Wells may be made from reinforced concrete, metal (steel pipe), PVC or Galvanised iron culvert pipe with the seams soldered. Concrete stilling wells are usually recommended for bank type installations in India and steel pipe wells for fixing from bridges. The well should have a sealed bottom and must be effectively watertight apart from the inlet.
- g) The dimensions of the intakes shall be large enough to allow the water level in the well to follow the rise and fall of the river. Conversely, the dimensions of the intake shall be small enough to damp out oscillations caused by wave action or surges. The computational procedure to dimension the pipes is presented at the end of the Sub-section. Leupold and Stevens, the well-known, long established manufacturers of hydrometric equipment, recommend that the area of the water inlet should be about 1/1000<sup>th</sup> of the area of the stilling well. Where a pipe is used connecting the well with open water it may be somewhat larger than where the connection is made by a mere hole in the wall of the well. Also, where the inlet is placed at considerable depth, say in a reservoir application, the intake diameter may be considerably larger than if near the surface. Leupold and Stevens have suggested the following guidelines:

Diameter of float well (mm)	Diameter of inlet hole (mm)	Diameter of inlet pipe 5 - 10 m long (mm)
300	12	12
400	12	19
500	16	19
600	19	25
760	25	37
1000	32	50
1000 mm square	32	50
1000 x 1300 rect.	37	75
1300 x 1600 rect.	50	100

Table 8.1: Recommended intake sizes for different stilling well diameters

- 
- h) For a stilling well diameter of 1.5 m, an intake pipe diameter of 100 mm is recommended. A minimum of two possibly three intake pipes of this diameter should be installed at vertical intervals of about 0.3 m. Therefore if the bottom intake becomes blocked during high water the higher one(s) should continue to operate. A depth of 1.0 m should be allowed from the invert level of the lowest intake pipe to the base of the well. The invert level of the intake pipe should be installed at least 0.15 m below the lowest, estimated water level.
- i) Provision should be made for the cleaning of the stilling well and intake pipes. The following methods can be considered:
- Provision of a flushing tank whereby water under considerable head can be applied to the well end of the intake pipes. The tank is filled with water then a valve(s) is (are) opened which allows the water into the intakes.
  - An alternative to i) above is to close the intakes by means of valves or a plug and then pump water into the well, then open the well or remove plug to flush out the intakes. This method is to be preferred since it saves constructing a flushing tank. Also, one portable pump can service a group of sites.
  - Hand cleaning of well sump and rodding out of intake pipes.
  - It is desirable that intake pipes greater than 20 m in length are provided with an intermediate manhole fitted with internal baffles to act as a silt trap and to provide access for cleaning.
- j) The intake pipe shall be laid at 90° to the direction of flow preferably at a slight constant slope to prevent air pockets forming in the pipe. It is recommended that whenever possible the intake pipe is flush with the bank of the river. This is not always possible in natural channels and it is sometimes necessary to extend the pipe out into the river channel e.g. where the minimum water level occurs in the centre of a wide, flat river bed. Whenever possible it is recommended that bank works are undertaken in concrete or stonework to create a stable position flush with the bank for the entry to the inlet pipe.
- k) The base of the instrument house above the well should be at least 1.0 m above the maximum, historic flood level. The instrument house should be weatherproof and adequately ventilated. If the stilling well is constructed of concrete, the instrument house could also be of a concrete construction. For bank stilling wells an instrument bench of solid timber or metal construction on which to place the float pulley and recording equipment should be installed. Slots should be provided in the bench prior to commissioning for the installation of the pulley wire, float and counterweight. For wall and bridge mounted stilling wells an access ladder and instrument platform shall be provided. A weatherproof instrument box of at least IP65 standard (See Sub-section 8.1.5) should be provided securely fixed to the platform. All instrument houses shall be weatherproof and secure from malicious interference.
- l) For bridge or wall mounted stilling wells where an intake pipe is not required, the bottom of the stilling well pipe shall be sealed and intake hole(s) shall be drilled at the lower end of the pipe. An indication of the hole diameter required is provided in Table 8.1. From this table it can be seen that for a stilling well of 500 mm diameter an intake hole of 16 mm is recommended. In some circumstances where the bottom of the pipe could be prone to siltation it might be better to have several holes at different elevations above the bed of the river.
- m) A fixed reference mark should be established at the top of stilling wells so that the position of the water surface inside the well can be established relative to a known datum (mean sea level) so that this can be compared with the water level in the river. The position of the water level in the well relative to the reference point can be established using a tape gauge (See Chapter 6). The position of the water level in the well relative to GTS can thus be determined. This should be compared with the external stage reading relative to GTS. If a significant difference occurs (> 1 cm) this could be due to stilling well and/or intake siltation or another problem e.g. gauge post slip. An alternative to establishing a reference point for larger stilling wells is to install a staff gauge on the inside of the well with the same zero as the external gauges. However, such an installation can be difficult to read without the aid of step irons and a torch.
- n) The entire structural design and construction specifications e.g. concrete mixes etc. shall be in accordance with the current Indian Standards.

A sketch of an outline design for a typical bank stilling well is shown in Figure 8.2 and a typical arrangement for a bridge-mounted installation is shown in Figure 8.3.

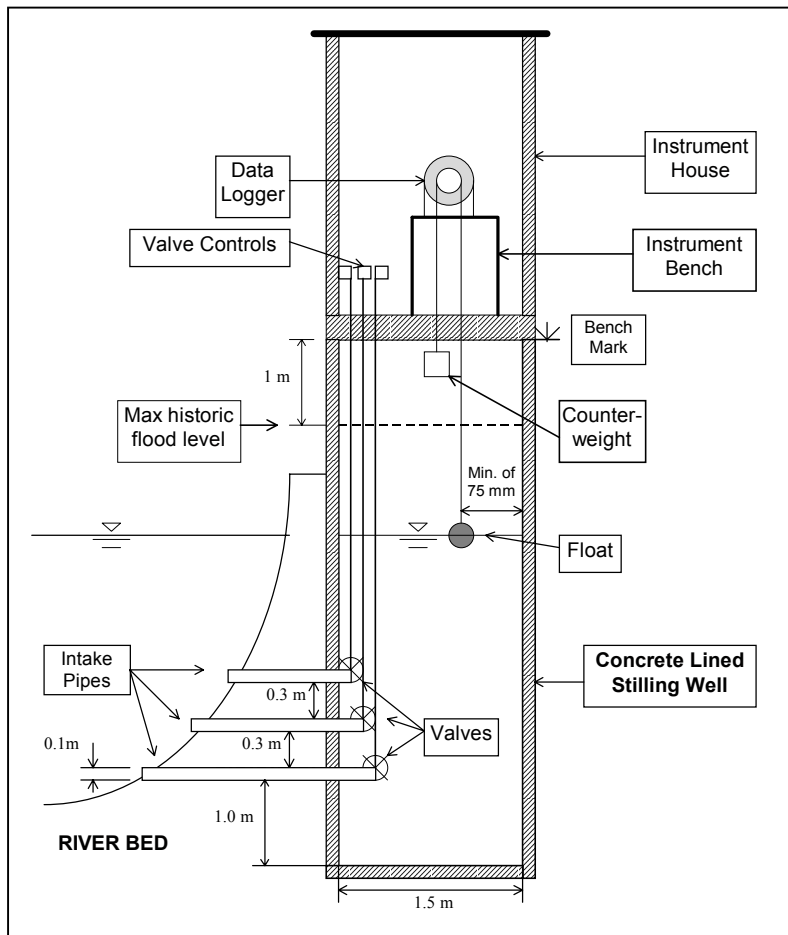

Figure 8.2:  
Sketch of typical bank stilling well arrangement

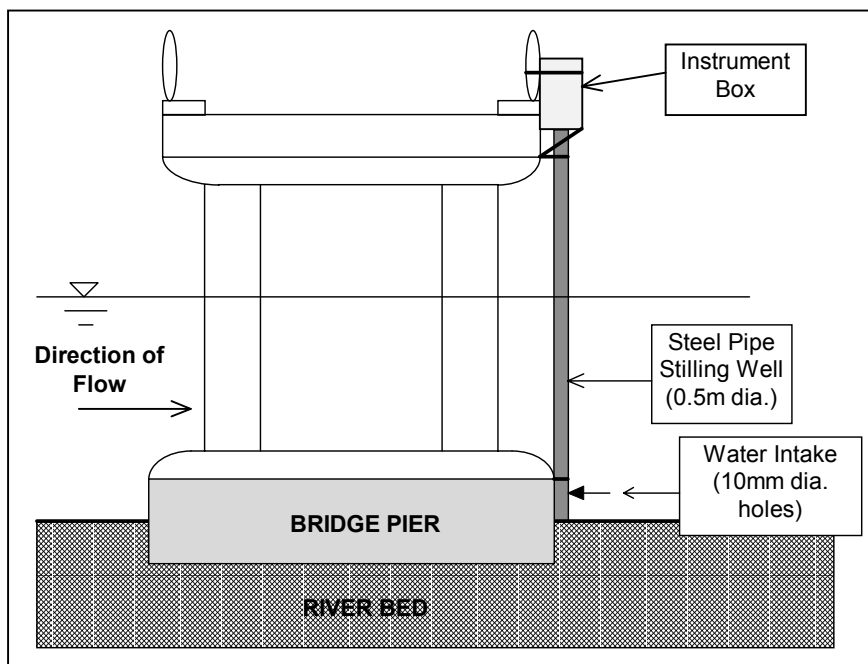

Figure 8.3:  
Sketch of typical stilling well arrangement for a bridge pier

### Adjustment

If the velocity past the end of the intake is high, **draw-down** (rising stage) or **superelevation** (falling stage) of the water level in the stilling well, depending on the angle of the intake opening(s) relative to the flow, may occur due to dynamic effects and disturbance caused by the protruding end of the pipe. These differences in height may be as much as 0.3 m, and they vary not only for different stages but also for the same stage of the river (Hersch, 1992). Stilling wells attached to bridges or walls usually have holes drilled in the stilling well casing to allow the passage of water rather than intake pipes. In such circumstances the dynamic effects can be even more significant than with intake pipes.

In order to reduce this drawdown or superelevation, static tubes are often placed on the stream end of the intake pipe. The static tube consists of a short length of pipe, 0.5 m long, attached to a 90° elbow on the end of the intake pipe and extending downstream in the same horizontal plane as the intake. The end of the tube is capped and water enters or leaves through holes drilled in its sidewalls.

### Determination of stilling well lag

The **stilling well lag** is a measure of the head loss in the intake system. The following relationship may be used to determine the lag for an intake pipe for a given rate of change in stage:

$$h_l = \frac{W}{2g} \left( \frac{A_w}{A_p} \right)^2 \left( \frac{dh}{dt} \right)^2 \left( \frac{1}{n} \right)^2 \quad (8.1)$$

where:

$h_l$	=	the amount of lag (m)
$W$	=	the coefficient of head loss in the connecting pipe and fittings
$A_w$	=	horizontal cross-sectional area of the stilling well (m <sup>2</sup> )
$A_p$	=	cross-sectional area of the intake pipe (m <sup>2</sup> )
$dh/dt$	=	rate of change of stage in the river (m/s)
$n$	=	number of intake pipes

For a straight connecting intake pipe with no control fittings:

$$\text{Entry loss} = 0.5 \frac{v^2}{2g}$$

$$\text{Exit loss} = 1.0 \frac{v^2}{2g}$$

$$\text{Friction loss} = \frac{\lambda L}{D} \frac{v^2}{2g}$$

$$\therefore W = 1.5 + \frac{\lambda L}{D} \quad (8.2)$$

Where:

$\lambda$	=	Darcy-Weisbach pipe flow formulae coefficient of total drag
$L$	=	length of intake pipe (m)
$D$	=	diameter of intake pipe (m)
$v$	=	velocity in the intake pipe (m/s)

$$\text{If there is a valve fitted the head loss} = 2.0 \frac{v^2}{2g}$$

$$\text{and} \quad \therefore W = 3.5 + \frac{\lambda L}{D} \quad (8.3)$$

### 8.1.4 DWLR - PRESSURE SENSOR TYPE

DWLRs of the pressure sensor type are described in Chapter 6. Pressure sensors do not require the installation of a stilling well. They are much cheaper to install than conventional float and chart recorders or shaft encoders but slightly less accurate than the latter. Also, the recording equipment can be remote from the riverbank since the data is recorded digitally. The pressure sensor type DWLR consists of three main parts:

1. The sensor, which has to be installed below the surface of the water at or below the minimum level to be measured. For river applications the sensor should be vented to atmosphere.
2. The connecting cable, which is the means of communicating with the sensor and also carries the atmospheric vent tube.
3. The logger, depending on make, this can either be integrated with the sensor or on the riverbank.

#### *Installation guidelines*

Some general installation guidelines are as follows:

- a) **Pressure sensors do not require stilling wells.** The damping out of wave oscillations can be undertaken using an electronic filter or an algorithm incorporated into the data logger software. However, in order to protect the DWLR from flood damage or human interference when used in the river environment it is recommended that some form of cable protection is provided e.g. a cable duct or small diameter pipe. When they are used in observation boreholes it is often sufficient to merely hang them from a permanent fixing at the top of the well. The deeper the sensor is installed (or actually the deeper the opening of sensor guide tube) below the water surface, the less the measurement is affected by waves.
- b) **Pressure sensors and the connecting cable do not require to be installed vertically.** The sensor can be laid on its side or pointing downwards.
- c) The diameter of a typical pressure sensor very rarely exceeds 50 mm. Therefore, to install the sensor and cable in a duct or pipe greater than 100 mm is usually unnecessary and adds to the costs and complexities of construction.
- d) Even though it is permissible to suspend a sensor by hanging it from its own connecting cable care must be taken to ensure that the position of the sensor relative to datum does not move. If a transducer is hanging vertically in a well or pipe then some form of cable clamping device at the top of the pipe or wellhead is desirable. Also, the cable might require time to fully stretch i.e. cables usually arrive from the manufacturers coiled up. Where possible, particularly on the bank installations described below. In vertical or slightly slanted installations, the sensor may be lowered to a stop at a convenient depth. If the sensor rests on the stopper, then the reproducibility and stability of the installation is taken care of.
- e) **Bank installations:** if pressure transducers are to be installed at the side of the river it is recommended that they be inserted in small diameter pipe of say 75 - 100 mm diameter. This pipe could be of PVC or Galvanised Iron. This pipe could be run down the side of the bank buried about 0.3 - 0.5 m below the surface. The pipe should be anchored to concrete foundation blocks. It is suggested that the gauge post anchor blocks are used for this purpose since the pressure transducer should be installed at the same location as the gauge posts. The bottom end of the pipe should be open to allow the free passage of water. Several installation/fixing arrangements are possible. An example is given in Figure 8.4. In slanted installations the sensor may be attached to a plastic rod, e.g. electricity pipe and pushed towards the stopper. The steeper the installation is the better, to avoid accumulation of sediment on the sensor.
- f) **For bridge and wing wall type installations** e.g. on dam walls, the pressure transducer should be installed in a Galvanised or PVC pipe similar to the that proposed for a bank installation. This should be fixed to the walls securely using standard pipe clamps and appropriate concrete/masonry fixing bolt. A possible bridge fixing arrangement is illustrated in Figure 8.5.
- g) For some **very, wide Indian rivers** with a relatively large range of water level but which can drop to very low flows or dry up, the positioning of a water level monitoring site can present difficulties.

Sometimes where these rivers have mobile beds the flow takes place in several channels at low flows and takes place a long way from the well-defined banks. One solution in some circumstances might be to install a triangular latticework tower close to the centre of the river channel, at or close to the minimum bed level. A pressure sensor could be installed in a protective conduit fixed to the tower and a recorder platform and instrument box secured to the top. A sketch of this type of arrangement is shown in Figure 8.6. This type of arrangement is possible, since a DWLR can, if necessary be left unattended for several weeks. The mode of installation is similar to that on a bridge pier.

- h) For all the above possible, installation arrangements it is recommended that two draw strings are installed in the pipe. This would facilitate the removal and re-installation of the sensor for maintenance purposes and could avoid the necessity of removing/unfitting the protection conduit/pipe. In slanting installations, the push rod could be used to pull the sensor back provided properly designed. The metal of the sensor should not be in permanent contact with any metal, e.g. galvanised steel pipe.
- i) It is not necessary to install a full instrument house for this type of sensor. This can further reduce the cost of the installation. For both the bank and bridge or wall type installation the sensor can be installed in a weatherproof, secure instrument kiosk or box or in the protection tube. For bridge installations the logger can be housed in a box on an instrument platform fixed to one of the bridge piers. Alternatively, the signal cable can be run in a duct to an instrument kiosk on one of the banks. Suitable dimensions for an instrument kiosk would be 750 mm long x 500 mm wide x 500 mm high. This could sit on concrete plinth 750 mm long x 500 mm wide x 1200 mm high. The instrument should be fixed to the plinth using internally accessible bolts and all opening should be sealed to prevent moisture ingress. A cable duct should be built into the plinth to allow the passage of the cable from the protection pipe into the recorder box. The kiosk should be weatherproofed to at least IP65 standard (see Sub-section 8.1.5). Provision should be made to ensure that the atmospheric vent tube is vented to atmosphere. However, some form i.e. hydrographic filter and desiccator of moisture protection will also be required to prevent ingress of water into the vent tube. The manufacturer/supplier should be required to provide this.
- j) General specification for a pressure sensor and data logging system is contained in 'Equipment Specification, Surface Water'. However, it should be noted that individual specifications should be site specific.

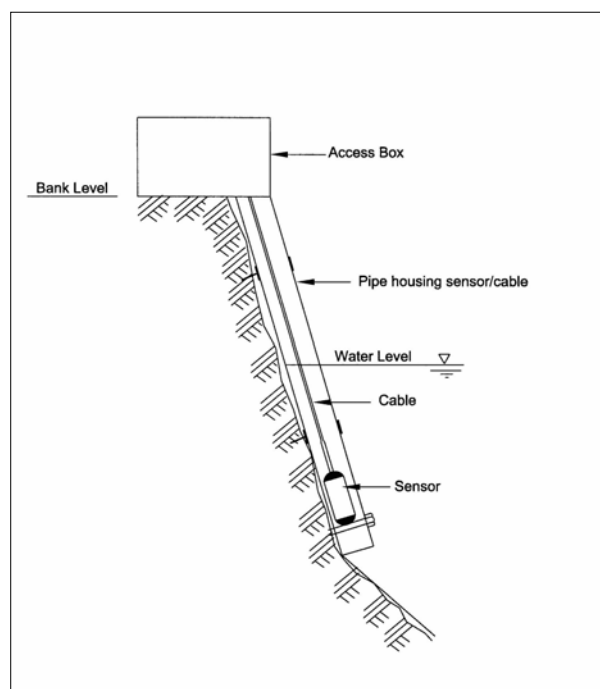

Figure 8.4:  
Sketch of bank mounted DWLR of pressure sensor type arrangement

- Stopper should freely pass sediment avoiding accumulation of the same.
- The stopper should prevent the sensor to pass.

- For easy construction the stopper could be bolt passing through the middle of the tube. In wide tubes a grid of bolts or similar would be needed.
- The bolts should be secured against loosening or the sensor, which is resting on it may fall.
- If there is a high risk of sedimentation, the sensor may be kept at a higher level or the openings of the sensor may be covered by filter cloth preventing the sediment to reach the sensitive sensor membrane. If this is done, the sensor will continue measuring even when covered by sand.

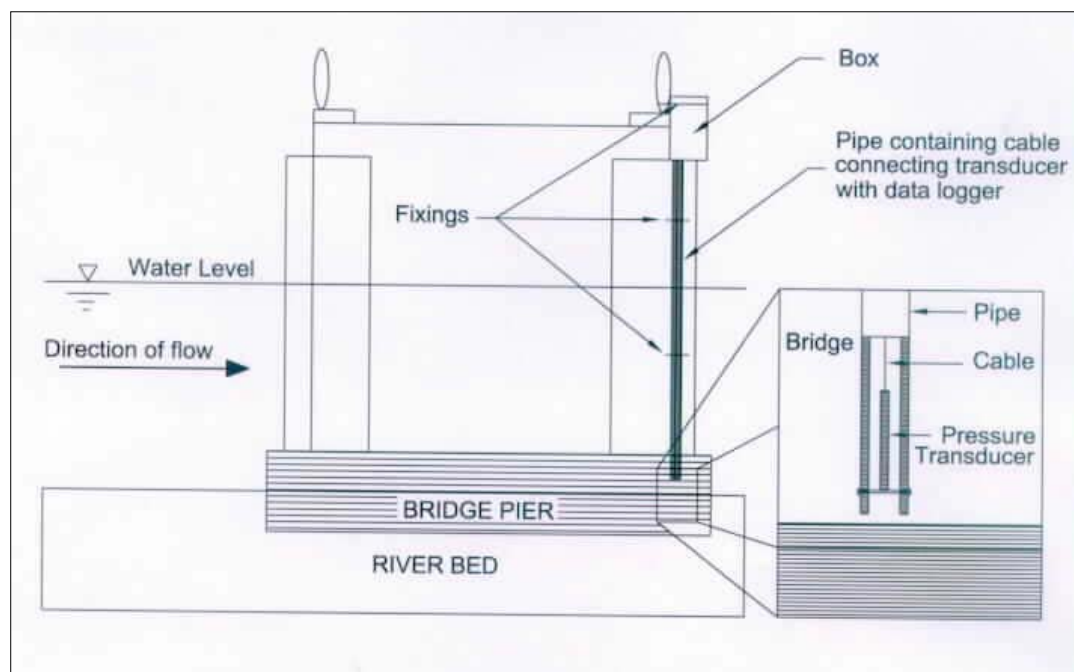

Figure 8.5: Sketch of possible arrangement for bridge fixing of DWLR of pressure sensor type

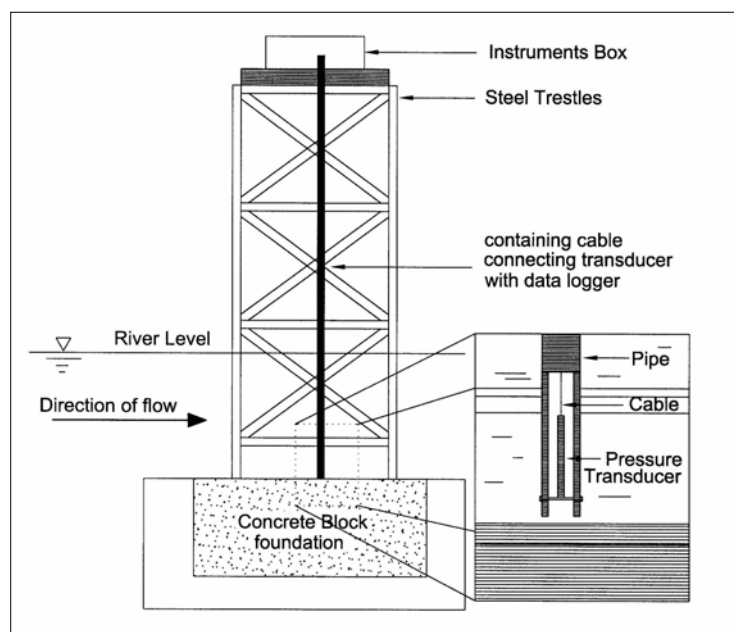

Figure 8.6: Sketch of tower mounted DWLR of pressure sensor type arrangement



### 8.1.5 INSTRUMENT PROTECTION AND HOUSINGS

Awl's and DWLR's require protection from moisture, dust, human interference and other factors. An international system of rating the amount of protection provided by instrument housings and enclosures is the IP system. This is summarised in Table 8.2 below.

	<b>First number (protection against solid objects)</b>	<b>Second Number (protection against liquids)</b>
0	No protection	No protection
1	Protected against solid objects over 50 mm in size	Protection against condensation
2	Protected against solid objects over 12 mm in size	Protected against direct sprays of water up to 15° from vertical
3	Protected against solid objects over 2.5 mm in size	Protected against direct sprays of water up to 60° from vertical
4	Protected against solid objects over 1.0 mm in size	Protected against water from all directions - limited ingress permitted
5	Protected against limited dust ingress	Protected against low pressure jets of water from all directions - limited ingress permitted
6	Totally protected against dust	Protected against pressure jets of water from all directions - limited ingress permitted
7		Protected against the effect of immersion between 15 cm and 1 m.
8		Protects against long periods of immersion under pressure

*Table 8.2: Summary of IP Rating System*

#### EXAMPLE 8.1

An instrument installed in a housing with an IP rating of IP67 should be totally protected against dust and the effect of immersion between 15 cm and 1 m.

Therefore three points to note about IP ratings:

- they are self certified
- equipment only has to meet the classification on the first exposure, and
- equipment has no time span for applicability, i.e. it may only meet the specification when new.

If an instrument is located above a bank side stilling well of concrete construction it is normally housed in a building of substantial construction, also of concrete or brick. However, steps should still be taken to ensure that the building is adequately ventilated (airbricks) and watertight. In dry, windy weather dust is often a problem and in times of high humidity condensation can also be a problem. Therefore even when installed in such an instrument house, AWRLs and DWLR loggers should be provided with adequate environmental protection.

Many makes of AWLRs and DWLRs are supplied in protective housings, e.g. Ott chart recorders and some loggers. The majority of these do not offer protection from determined human interference. However, in most instances, apart from that of security it is not necessary to provide a complete building to house a chart recorder or logger. Modern loggers come in a variety of shapes and sizes from small rectangular boxes only slightly larger than a cigarette packet to enclosures as large as small suitcases. Therefore in many circumstances a large secure instrument box or kiosk secured to a concrete plinth or bridge pier or platform will suffice for most applications

Suitable internal dimensions for an instrument kiosk, depending on application could be 750 mm long x 500 mm wide x 500 mm high. This could sit on concrete plinth 750 mm long x 500 mm wide x 1200 mm high. The instrument should be fixed to the plinth using internally accessible bolts and all opening should be sealed to prevent moisture ingress. This would provide adequate room to install and maintain most types of water level recorder (chart or logger) including space for keeping log sheets and a maintenance manual. For a DWLR installation, a cable duct should be built into the plinth to allow the passage of the cable from the protection pipe into the recorder box. For DWLR's of the pressure sensor type care should be taken to ensure that the atmospheric vent tube is vented to atmosphere. However, some form i.e. filter dessicator of moisture protection will also be required to prevent ingress of water into the vent tube.

Sometimes recorder and logger boxes are well constructed and sealed, yet moisture ingress occurs through cable connectors or cable entry points. Care should therefore always be taken to ensure that cable and electronic connectors and connections are of a sufficiently high quality. When designing instrument houses and boxes provision should be made to prevent the ingress of moisture along cable ducts, atmospheric vent tube ducts etc. For example there are many modern sealing products which can be used to assist in this regard.

As human interference is often a problem, the logger or recorder housing should be made of a solid material such as concrete, brick or steel. Modern glass reinforced plastic (GRP) installations can also be made very secure from all but the most determined vandalism. The access door should be secured using an appropriate locking system and in some circumstances an additional locking strap can be fixed across the doorframe. Keyholes and padlocks should be provided with some form of protective cover.

If the data logger is well protected, say to IP67 standard, an alternative to an instrument kiosk is to install it in a manhole. This can have a lockable concrete or steel lid. Manholes are often less noticeable and susceptible to human interference. For temporary installations it is sometimes possible to conceal the logger by burying it provided an adequate venting arrangement can be made.

The logger, provided that it is small, could also be installed inside the sensor protection tube/cable guide tube. This on the assumption that proper fixing for the logger and proper locking/securing are provided.

## 8.2 DESIGN AND INSTALLATION CRITERIA - CURRENT METER GAUGING INSTALLATIONS

### 8.2.1 GENERAL

The choice of current meter gauging method is very dependent on the physical conditions and the range of flows and stages experienced at the site. At many sites two, even three deployment methods will be required. The guidelines used by CWC for selecting the method of deployment are reproduced in Table 8.3 below.

	Width of River	Equipment Proposed
1	Up to 60 m	staff gauges, wading current meter gauging up to 0.9 m (3ft) and floats above this level
2	60 to 100 m	staff gauges, cableway with winch and cradle
3	100 to 300 m	staff gauges, boat cableway, FRP 6 m boat
4	300 to 800 m	staff gauges, FRP 8 m boat with 40 hp engine, boat outfit type C
5	+ 800 m	staff gauges, FRP 8 m boat, with 40 hp engine, boat outfit type B

Table 8.3 CWC Current meter gauging method selection guidelines

The above are a **very general guide and in some circumstances another method might be more appropriate**. For example it might be advantageous to install bank operated cableway systems on rivers less than 60 m wide and up to 200 m wide.

The following guidelines should be considered as an alternative to those listed above:

	River Width	Depth	Suitable Bridge (Y/N)	Equipment Proposed
1	< 200 m	< 1.0 m	Y/N	wading
		> 1.0 m	Y	bridge outfit
		> 1.0 m	N	bank operated cableway or boat (tag line or portable cable)
2	200 - 500 m	< 1.0 m	Y/N	wading?
		> 1.0 m	Y	bridge outfit
		> 1.0 m	N	winch and cradle (manned cableway) or boat (cableway or hold on position)
3	> 500 m	< 1.0 m	Y	Wading?
		> 1.0 m	Y	Bridge outfit? - depends on number of bridge piers/boat (hold on position)
		> 1.0 m	N	Boat - hold on position
4	> 500 m (important site)	> 2.0 m	N	Acoustic Doppler Current Profiler (ADCP)

Table 8.4: *Alternative Current Meter Gauging Selection Guidelines*

### 8.2.2 WADING GAUGING SITES

Wading gauging normally requires very little, permanent site preparation work. As it is often used in changing situations, in many circumstances it is often not possible to use the same site over the full range of wading gauging flows. However, if the same cross-section is being gauged on a regular basis it is recommended that permanent distance measuring line/tape anchor posts are installed. These are normally angle iron posts set in concrete blocks to which a measuring tape or graduated cable can be attached and pulled as taut as possible.

Specifications for wading gauging kit are contained in 'Equipment Specification, Surface Water'. For shallow flows the miniature or pygmy type of meter is preferred. A useful adaptation which is used in some States, is to have a rod system which has two scales one to measure the depth and the other to locate the meter at 0.6D. This type of device can avoid positioning errors when the operator has difficulties with mental arithmetic and/or is inexperienced.

### 8.2.3 BRIDGE GAUGING

Like wading gauging there is not a lot of site preparation work to be undertaken at a bridge gauging site. However, **permanent distance measuring marks should be established on the parapet of the bridge**. These should be at a **frequent enough interval to cover the full flow range**. It is normally recommended that whenever possible velocity measurements should be undertaken in a **minimum of 20 verticals** in watercourses more than 20 m wide. Therefore, 5 m intervals might suffice when the cross-section is 100 m wide but if it reduces to 40 m wide then 1 -2 m intervals might be required. At some sites the bridge piers result in the division of the cross-section into distinct compartments i.e. when the current meter is suspended between the piers. In such situations each **span is acting as a separate channel and the number of verticals/segments should be increased accordingly**.

General specifications for bridge gauging equipment are contained in 'Equipment Specification, Surface Water'. At high velocities in particular, the impeller type current meter with a long tail fin seems to align itself better than the more commonly used cup-type meters. The bridge gauging derrick jib should be of sufficient length to suspend the current meter well away from any protrusions on the bridge.

#### 8.2.4 CABLEWAY GAUGING

There are two basic types of cableways, namely:

- a) those with an instrument carriage or trolley controlled from the river bank; and
- b) those with a carriage or trolley in which the observer(s) travel and make the observations

**NOTE:** Boat cableway systems are discussed under boat gauging (Sub-section 8.2.5).

The **cableway with instrument carriage** consists of (see Figures 8.7, 8.8 and 8.9) the following:

1. **Towers** - Towers are erected, one on each bank of the channel. The towers should support the main cable at heights, which will ensure the unimpeded progress of the suspended equipment as it travels along the main cableway between them. The tower on the operating bank should have sheaves for guiding the suspension and tow cable and also as a means of securing the winch(es). The track or main cable must pass freely over the saddle on top of the tower at the operating bank with negligible bending moment on the tower. The tower on the bank opposite to the operating bank has a saddle on its top for the main cable and a sheave for the tow cable. The height of the tower on the opposite bank should be suitably fixed in accordance with the topography of the site.
2. **Track or main cable** - runs over the saddles on top of the towers and the two ends are fitted to the anchorages;
3. **Anchorages** - the track cables and staylines are attached to these.
4. **Tow cable** - this is the cable which moves the current meter backwards and forwards across the river. It is attached to one of the drums in the double drum winch or to one of the winches when two separate winches are used, and passes over the sheaves fixed to the towers. The two ends of the tow cable are fixed to the carriage. Therefore, it is an endless circuit. Alternatively, the endless circuit may be made by the tow cable (whose end is fixed to the carrier and the other end is wound on the drum) and the suspension cable;
5. **Suspension cable** - The suspension cable is wound on the second or a separate drum and passes over the sheave on the tower at the operating bank and then passes over the pulley in the carrier. The measuring instruments are attached to the end of the suspension cable. The cable incorporates an insulated inner core, which serves as an electrical conductor for transmitting the signals to and from the current meter.
6. **Instrument carriage** - this is often triangular in shape with the apex pointing downwards. Two track pulleys are fixed at the top and one at the bottom. The carriage runs along the track cable when pulled from either side. The suspension guide pulley guides the suspension cable. When spans are larger than 125 m, an additional guide pulley may be required.
7. **Double drum winch or two independent winches** - The double drum winch incorporates two drums. The suspension cable is wound on one of the drums and the endless tow cable on the other then over the sheave on the opposite bank. Alternatively the tow cable is wound on the other drum. Horizontal and vertical movements of the measuring instrument attached to the suspension cable are controlled by a lever which either couples only the suspension cable drum or both drums simultaneously. There should be counters on each drum to indicate the released length of cable, one for measuring the horizontal distance travelled by the carriage and the other indicating the depth, or sounding of the suspended

instrument. The depth counter should have a resolution of 1 cm and the horizontal distance counter a resolution of 10 cms. Winches are generally fitted with automatic brakes by which the suspended instrument is retained at the desired place.

- 8. **Staylines** - these are attached to the top of each tower to the anchorages to counteract the load of the main cable between the towers and to ensure the stability of the towers.

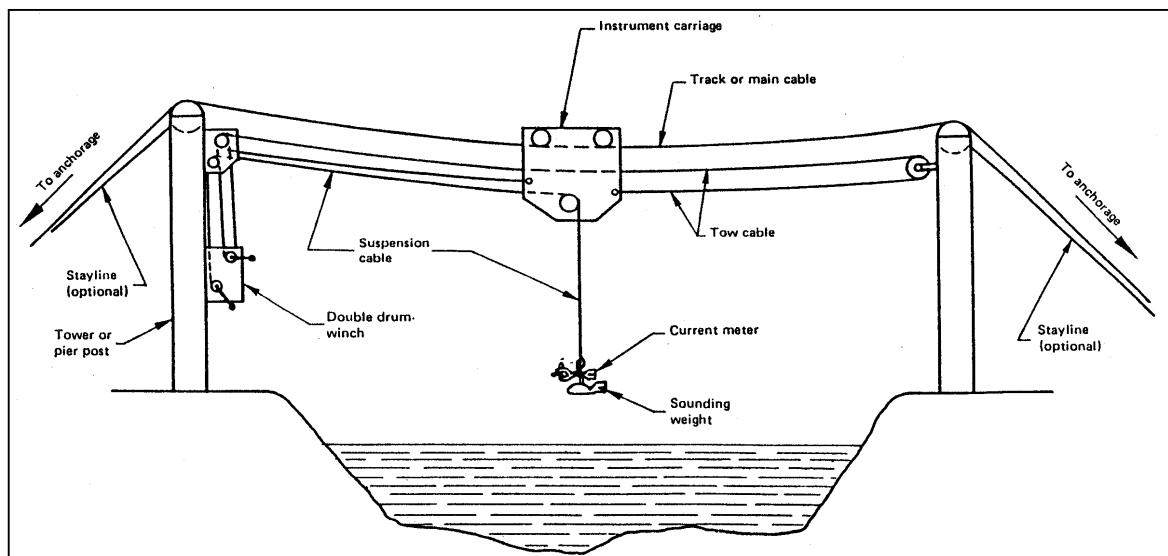
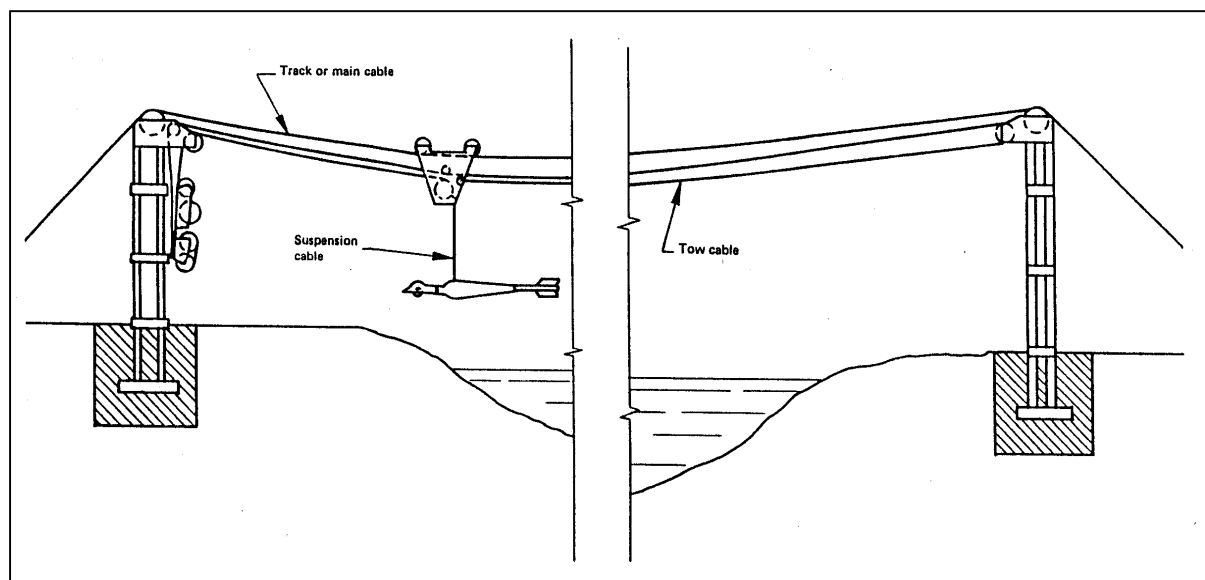

Figure 8.7: Unmanned cableway system with tow cables in endless circuit and separate suspension system



(Source:- SEBA Hydrometrie)

Figure 8.8: Unmanned cableway system with tow cable and suspension cable in an endless circuit

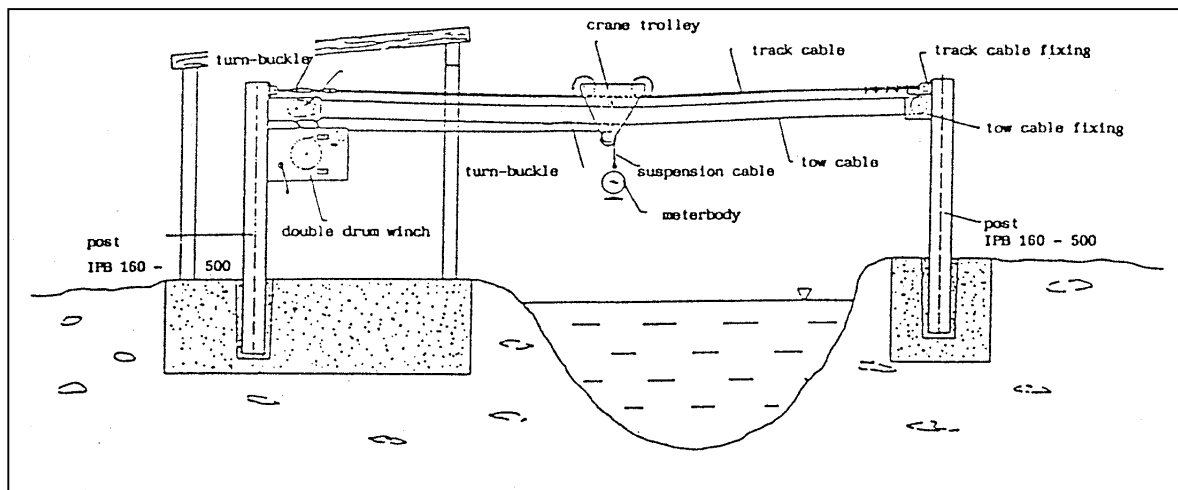

Figure 8.9: Seba cableway system with stanchion/column

The **cableway with manned carriage** consists of (see Figure 8.10):

1. Towers;
2. Track or main cable;
3. Anchorages;
4. Staylines;
5. Carriage.

Components 1, 2, 3 & 4 are similar to those described above for an unmanned carriage.

The **manned carriage** from which the observer makes the gauging, travels along the main cable by means of the two track pulleys. The carriage may be driven manually or by a power unit. The power driven units are usually used on wider spans. Some systems in use in India are driven by diesel powered motorised winches. The carriage should be designed so that observations can be made from both the sitting and standing position. A suspension winch, which is in accordance with the general bridge gauging specification, should be installed in the carriage. A pair of adequate wire cutters should be permanently kept in the carriage (cradle) in the event that debris catches round the suspension cable this can be cut to avoid risk of the life of the operator(s).

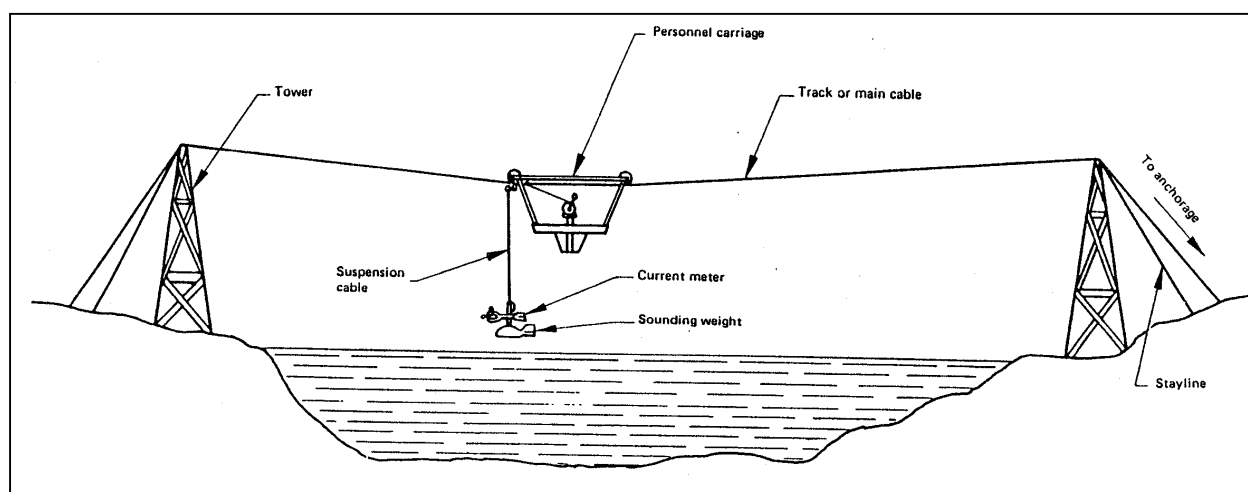

Figure 8.10: Manned cableway system

### ***Design guidelines for cableway systems***

These guidelines are based mainly on ISO 4375 - 1979 and current accepted Indian and International practice. Type designs for manned carriage cableway systems are available in several States e.g. Maharashtra. For the design of unmanned bank-operated cableways the 'Guidance on the design of cableways', Hydrology Project, October 1998 should be consulted. The document is included in the Volume 4, Reference Manual on Hydrometry. Design criteria for the cableway components are listed below.

#### ***Safety factor***

All the components of the system shall be designed to provide a minimum safety factor of 2 for unmanned carriages and 5 for manned carriages at maximum load.

#### ***Towers***

1. They should be accessible at all times of year. The towers shall be designed to take all loads which are to be supported, including their own weight and wind loads. The height of the towers shall be such that the bottom of the equipment, suspended from the centre of the main cable span, **should not be less than 1 m above the maximum flood level. Also, the cable should be high enough so as not to prevent any hazard to navigation.**
2. Towers should be constructed of suitable steel material with the required strength to meet the design criteria. The type of constructions should take account of local availability of material, strength and cost. Many of the towers installed in India are of the 4 legged lattice work type. However, it is also possible to construct the unmanned cableway towers from steel columns. (Figure 8.9).

#### ***Track or main cable***

The sag shall not be more than 2%.

The tension in the cable suspended between supports of equal height and neglecting additional tension due to wind load on the cable is given by the formula:

$$T = \frac{wS^2}{8D} + \frac{PS}{4D} \quad (8.4)$$

Where: T = the horizontal tension in the cable, in Newton's  
 w = is the weight per metre run of wire rope or cable, in Newton's  
 S = horizontal span, in metres  
 D = the ultimate sag in metres  
 P = the concentrated moving load, in Newton's

The actual tension in the cable is given by:

$$F = T \sqrt{1 + \frac{16D^2}{S^2}} \quad (8.5)$$

The main cables in the cableway shall be corrosion resistant. For short spans, wire rope may be used but for larger spans special high tensile cable will be required.

---

For manned systems distance markers should be fixed or painted on the main cable in order to fix the position of the carriage. These marks should be sufficiently frequent to allow sufficient segments to be taken at the lowest gauged flows.

### ***Anchorage***

1. These shall be adequate to sustain the maximum load for which the cableway is designed.
2. The anchorage should be set in a direct line with the track cable.
3. The anchorage should be placed so it can be easily inspected.

### ***Staylines***

1. These should be constructed of corrosion resistant material and be of sufficient strength to sustain the tower in a vertical position.
2. It is necessary to provide a means of adjusting the tension in the staylines.

### ***Tow cable***

Should be light, flexible and corrosion resistant but have sufficient strength to move the carriage. There should be a means of adjusting the tension in the cable if it makes an endless circuit.

### ***Suspension cable***

1. Should be light, flexible and corrosion resistant but have sufficient strength to move the current meter and the maximum size of sounding weight.
2. The cable should preferably be preformed and reverse laid to prevent spinning.
3. The cable should be fitted with a suitable attachment for the fixing of the current meter gauging equipment.
4. An insulated conducting cable should be incorporated into the cable for transmission of the signal from the current meter. The cable connections between the cable and the current meter should be robust and suitable for use in a harsh, water environment.
5. The cable shall be smooth and flexible so it can take turns without any permanent bends or twists which could effect its design life and its length.
6. For unmanned systems some form of angle siting device should be fitted on the observation (winch) bank in order to estimate the angle of suspension from the vertical for making air-line and wet-line corrections.

### ***Unmanned carriages***

#### **Should:**

1. Have sufficient strength to support the measuring equipment;
2. Simple in design and protected against corrosion;
3. Permit the operation of the equipment without hindrance.

### ***Manned carriages***

#### **Should:**

1. Be of adequate strength to carry the observers (maximum of three), the measuring equipment.
2. There should be reasonable comfort for the operator and the observer who should be able to make reasonable movements safely;



3. An adequate, permanent support for the gauging winch should be provided;
4. There should be a braking system to fix it at the required position;
5. It should be equipped with an angle-measuring device in order to make measurements for the computation of air-line and wet-line corrections.

### ***Winches***

1. The winch should be able to carry the required loads of the meter suspension cable and tow cable;
2. The winch shall be provided with a locking device by which the suspended instrument can be fixed at any depth in steps not greater than 1 cm. a friction brake should also be fitted.
3. The winch should be fitted with guide pulleys in order to lay the cable evenly on the drums as it is wound in and out. the diameters of the drums on double drum winches shall be matched to ensure that the towing cable and suspension cable are payed out at the same rate;
4. The diameter of the drum should be greater than the minimum winding diameter recommended for the cable
5. There shall be an arrangement which enables the suspension drum to be disengaged from the traversing drum and to be operated independently or both drums;
6. If an electrical cored suspension cable is used the suspension drum shall have a suitable slip ring housing and connection for picking up signals transmitted by the current meters i.e., there should be the facility to connect the current meter revolution counter to the winch.

### ***Suspension weights***

In order to maintain the sounding and suspension cables as near vertical as possible the appropriate size of sounding weight is required. An estimate of the mass required is given by the following formulae:

$$m = 5\bar{v}D \quad (8.6)$$

where:  $\bar{m}$  = the mass of the weight in kg  
 $\bar{v}$  = the mean velocity of flow in m/s  
 $D$  = the depth in m

## **8.2.5 BOAT GAUGING**

Permanent installations for boat gauging could consist of one or more of the following:

- Boat cableway;
- Temporary cable or tag line anchor posts;
- Positioning system i.e. survey markers.

### ***Design considerations***

1. Boat cableway systems should be designed to the same criteria as the cableways referred to in Section 8.2.4. The loadings will be slightly different, as the main load will be that of the boat being acted upon by the current. However, if a maintenance trolley is to be provided then it should be designed to the normal manned carriage standards.
2. At some boat gauging sites particularly in lower flows and narrower channels temporary cables or tag lines can be stretched across the river which are removed after each gauging or when the river starts to move out of the measurable flow range. At permanent sites it is sometimes worthwhile installing a series of anchor posts on each bank similar to gauge posts to which to attach and tension the measuring cable or line. These can be set at appropriate levels down the

bank of the river and set in concrete foundations similar to those for a gauge post. The bow of the boat can then be readily fixed to the cable which will be close to the water level.

3. The positioning system most commonly used in India is the pivot method whereby the boat is lined up with known reference points on the banks and a master reference beacon. The reference points have distance points marked on them so that when the boat is in line with a particular reference point and the beacon its position across the measuring section is known. This method is practised at many CWC sites and standard designs and procedures are available. The method is described in Chapter 6.
4. When its not possible to fix the boat to a cable it can be held in position by an anchor and/or the engine. A skilled boat operator is usually required for the latter.
5. With the advent of modern depth, velocity and position measuring systems the moving boat method has become a very important gauging technique in some river systems. This is described elsewhere since it requires very specialist equipment, is costly and is to be evaluated as part of a pilot project. Therefore, it has not been included in these general guidelines.

## 8.3 SITE OFFICES AND STORES

### 8.3.1 SITE TYPES

The need for and the design of site offices will be dependent on a number of factors including the type of gauging station, the nature of the site, the manning levels and equipment required and the logistical support facilities within the overall area or region. In order to provide some guidelines on site office and store requirements an indication of manpower level requirements for different categories of site is required. An estimate of manpower requirements has been prepared for this purpose and these are summarised in Table 8.5 below. However, it has to be emphasised that this table refers to a network of stations of uniform characteristics whereas in practice within each geographical and administration area there will be a range of stations with various levels of importance with respect to function and varying levels of difficulty in measurement. Also, manpower requirements will by necessity vary between States and even within States. In addition, other combinations of measurements may be made other than those listed in the table.

Type code	Station type	Perm. staff	Seasonal staff	Gauging stations/team	No. per team
L1	Level only with staff gauge (SG)	1	+2	8	1
L2	Level only with AWLR	1	-	8	1
FL1	SG and float gauging	1	+2	6	1
QL1	Flow gauging structure with AWLR	1	-	6	2
QL2	Flow with AWLR and stable control defined by gauging	1	-	5	2
QL3	Flow with SG and stable control defined by gauging	1	+2	5	2
QL4	Flow with AWLR and defined by cableway or bridge gauging	1	-	3	3
QL5	Flow with SG with variable control defined by cableway or bridge gauging	1	+2	3	3
QL6	Flow with AWLR and variable control defined by boat gauging	1	-	2	3
C1	Flow with AWLR with variable control (broad channel) defined by boat gauging, sediment and WQ sampling and analysis	6	-	1	(4)

Table 8.5: Estimated manpower requirements for different types of gauging station

### 8.3.2 ASSUMPTIONS

It has been assumed that level only stations, AWLR or DWLR only and level with float gauging only stations i.e. types L1, L2 and FL1 will be attended to on a regular basis by a local, resident observer who will not require any on-site facilities or accommodation. As such no permanent on site office or storage accommodation should be required.

Flow measurement structures with AWLRs or DWLRs should in theory only require periodic visits for chart changing or data downloading and maintenance purposes e.g. clearing of debris from structure. However, in practice current meter gauging will be required to check the performance in the modular range and to calibrate it above the modular limit. Nevertheless structures will be equipped with stilling wells and instrument houses. As such there should be adequate space in the instrument house for the storage of equipment on site if required e.g. current meter and accessories. If a bank operated cableway is installed the winch will be protected from the elements by some form of housing. Therefore, no additional on site office or storage facilities should be required. To provide such facilities would defeat the object of installing AWLR's and structures since one of their benefits, if designed properly is the fact they can be left unattended for prolonged periods, while at the same time providing continuous flow records.

Other types of stations other than those referred to in 1) and 2) above will possibly require some form of storage and office facilities. Stations which will definitely require such facilities will include:

1. Those which are permanently manned other than by a locally resident gauge reader;
2. Stations where equipment e.g. current meters are permanently allocated to one site;
3. Sediment sampling and water quality monitoring stations;
4. Stations where on-site analysis is required;
5. Stations where records are required to be stored on site.

### 8.3.3 GUIDELINES

On-site offices and stores should be designed to withstand all but the most severe cyclones. The choice of construction material will depend on current practice and the availability of local materials.

It is suggested that the following is allowed for -

1. Site supervisor - 12 m<sup>2</sup>
2. Other permanent and pensionable site staff - 9 m<sup>2</sup> each
3. Gauging assistants/labourers - allow 4m<sup>2</sup> per person;
4. Equipment store - 6 to 15 m<sup>2</sup> depending on type of site
5. Sediment laboratory - 15 m<sup>2</sup>
6. Toilet and washing facilities.

In addition to the above the following might be required, depending on the remoteness of the location, at permanently manned sites:

- Kitchen area;
- Sleeping quarters, allow say 6 m<sup>2</sup> per person.

The kitchen area and sleeping quarters should be in a separate building from the offices and stores.

A ceiling level of a minimum of 2.5 m is recommended for all buildings.

## Other considerations:

1. At sites where records such as charts will be stored for more than a month before transferring to a secure sub-divisional or divisional office, a secure dustproof, waterproof and fireproof record storage cabinet or safe should be provided.
2. Sediment sampling laboratories should be equipped with a drying oven, water supply and sink. A laboratory bench at least 3 m long and 1 m wide should be provided. This bench should be of a solid timber construction and should be rigid.
3. The instrument stores should be equipped with heavy duty shelving on which to place instruments such as current meters, sampling equipment, sample bottles and other accessories. Current meters should always be placed in their own specially designed box when not in use, either for transportation or storage purposes.
4. The provision of desks, tables, filing cabinets and cupboards will be site specific. However, it is recommended that care is taken to ensure that adequate work space and paper storage facilities are provided.
5. Water quality laboratory space and other requirements, have been covered separately in Volume 7.

### 8.3.4 POSSIBLE BUILDING REQUIREMENTS

The following Table 8.6 provides guidelines on possible office/storage requirements for different categories of flow measurement site:

Category	Type of site	Office space (m <sup>2</sup> )	Storage space (m <sup>2</sup> )	Sediment laboratory (m <sup>2</sup> )	Sleeping quarters etc. (m <sup>2</sup> )	Remarks
QL2	Flow with AWLR and stable control defined by gauging station	N/A	6	N/A	N/A	As control is stable it is assumed that there would be no need for gauging on a daily basis
QL3	Flow with SG and stable control defined by gauging	N/A	6	N/A	N/A	As control is stable it is assumed that there would be no need for gauging on a daily basis
QL4	Flow with AWLR and defined by cableway or bridge gauging	12	10	N/A	N/A	Even though the station might not be continuously manned it could be useful to have some office facility on site
QL5	Flow with SG with variable control defined by cableway or bridge gauging	12	10	N/A	N/A	Even though the station might not be continuously manned it could be useful to have some office facility on site
QL6	Flow with AWLR and variable control defined by boat gauging	21	15	N/A	N/A	
C1	Flow with AWLR with variable control (broad channel) defined by boat gauging, sediment and WQ sampling and analysis	37	15	15	40	The sleeping accommodation includes for a kitchen

Table 8.6: Possible building requirements for different types of gauging sites

---

## 9 REFERENCES

- Chow, V.T. (1959)  
Open-channel hydraulics.  
McGraw-Hill, New York, ISBN 07-010776-9
- Cobb (1993)  
Broad-Band Acoustic Doppler Current Profiler.  
US Geological Survey Office of Surface Water.
- DRL (1996)  
Acoustic Measurements of Sediment Flux through the Mersey Narrows.  
Environment Agency North West Region
- Gordon (1989)  
Acoustic Measurement of River Discharge.  
Journal of Hydraulic Engineering, Vol. 115, No. 7
- Hershy, R.W. (1995)  
Streamflow Measurement.  
2<sup>nd</sup> Edition, E & FN Spon, London.
- Jansen, P.Ph.et.al. (1979)  
Principles of River Engineering  
Pitman (London)
- Jarvis, Waters & Adams (1995)  
Preliminary Investigations to Determine the Potential of the Acoustic Doppler Current Profiler for River Flow Measurement.  
BHS 5th National Hydrology Symposium, Edinburgh.  
RDI (1989)  
Acoustic Doppler Current Profilers Principles of Operation: a Practical Primer.
- Julien, P.Y. and G.J. Klaassen (1995)  
Sand-dune geometry of large rivers during floods.  
Journal of Hydraulic Engineering, ASCE, Vol: 21, No. 9.
- RDI (1995)  
RD Instruments; ADCP River Discharge Manual. RD Instruments quick reference instruction manual.
- Rijn, L.C. van (1984)  
Sediment transport, Part III: Alluvial Roughness.  
Journal of Hydraulic Engineering, ASCE, Vol: 110, No. 12.
- Rijn, L.C. van (1980)  
Principles of Fluid Flow and Surface Waves in Rivers, Estuaries, Seas and Oceans.  
AQUA Publications, Amsterdam.
- Delft Hydraulics & Danish Hydraulics Institute (1996)  
River Survey Project FAP24, Special Report 11 - Optimisation of Hydraulic Measurements.  
WARPO, Bangladesh/EU.